

DRAWING CONVENTIONS CONFORM TO IS : 680
 DIMNS ARE IN m.m. UNLESS OTHERWISE STATED
 GEN TOL. MEDIUM/COMMON CLASS TO IS : 2102

DRG. No. ARDE 2283
 DET. No. 4
 SHTS. 5

Issue to the C.M., O.P., Dum Dum

अनुमोदित तथा निरीक्षण विभाग के द्वारा सुनिश्चित
 Verified Suitable to quick Manufacture
 & Inspected
 दिनांक: 06/09/18
 हस्ताक्षर: [Signature] Rank: Foreman
 S No. []
 कर्तव्य: []
 Directorate General of Aeronautical Quality Assurance.

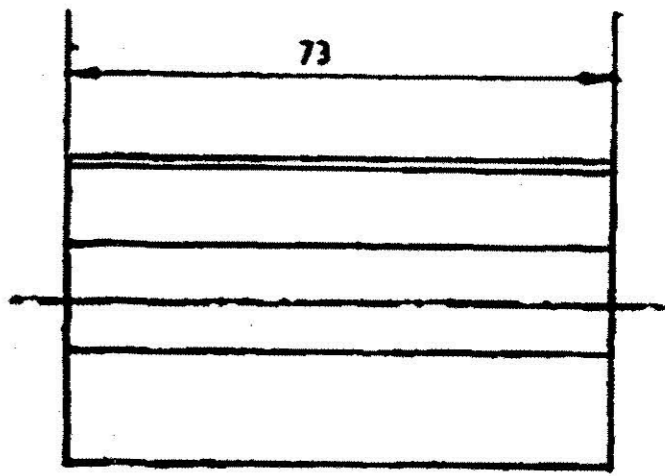
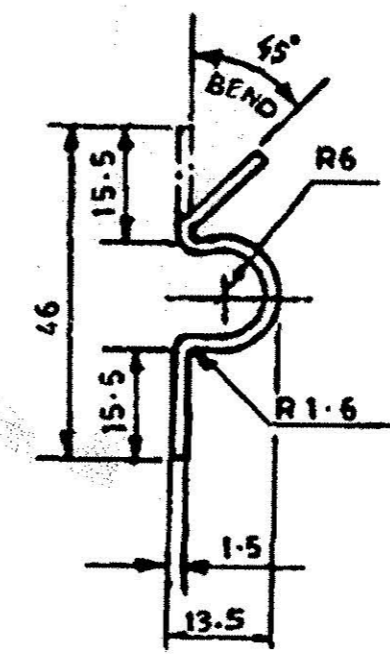
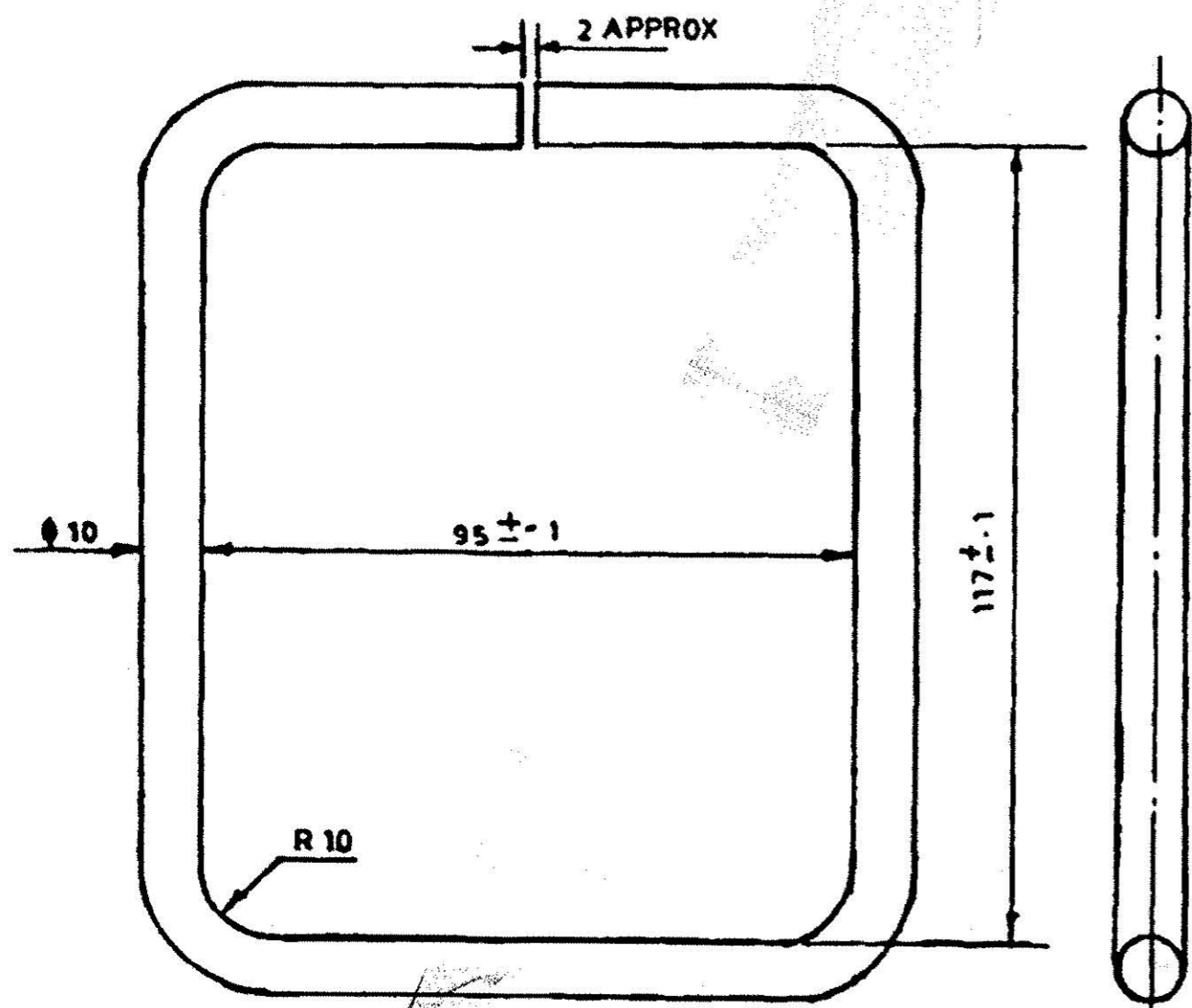

CLEAT - 2 OFF

MATL
STEEL TO IS:1570-C 20

HANDLE - 2 OFF

MATL - STEEL TO IS:613-Gd 'O' ANNEALED CONDITION
PROTECTIVE FINISH FOR HANDLE & CLEAT
PHOSPHATING TO IS:3618 CLASS 'B' OILED & STOVED.

DRN	SMP	CHD.	TRD.	COMP.	ASSY DRG. ARDE 2283 SHTS 4
CD		PASSED	SCALE: 1:1		DESIGN AUTHORITY
APPROVED		[Signature]	EST MASS:		ARDE PUNE - 411 021
		FOR DIRECTOR	GAUGE SCHED:		
R NO	DATE	AUTHORITY	DATE 28.6.95		
DRG SEALED (PROV)		BRIEF RECORD	MATL: AS ABOVE		
		ZONE	PROTECTIVE FINISH: AS ABOVE		

TITLE:

HANDLE & CLEAT

DRG. No.
ARDE 2283

DET. No. 4 SHTS. SHT. No.

PART No.

D.E.CAT.No.

A.M.S.P.

DRAWING CONVENTIONS CONFORM TO IS 696
 DIMS ARE IN mm. UNLESS OTHERWISE STATED
 GEN TOL. MEDIUM/COURSE/FINE CLASS TO IS 2102
 PART No. 5
 DET No. 5
 ARDE 2283
 ON/DMS

Issue to the GM, D.P., Dum Dum

उद्योगिक कक्षा विभाजन निदेशन के योग्य प्रमाणित
 Certified Suitable to quick Manufacture
 & Inspection
 Date 06/09/18
 Signature [Signature]
 Rank Foreman
 S No. [Blank]
 Directorate General of Aeronautical Quality Assurance

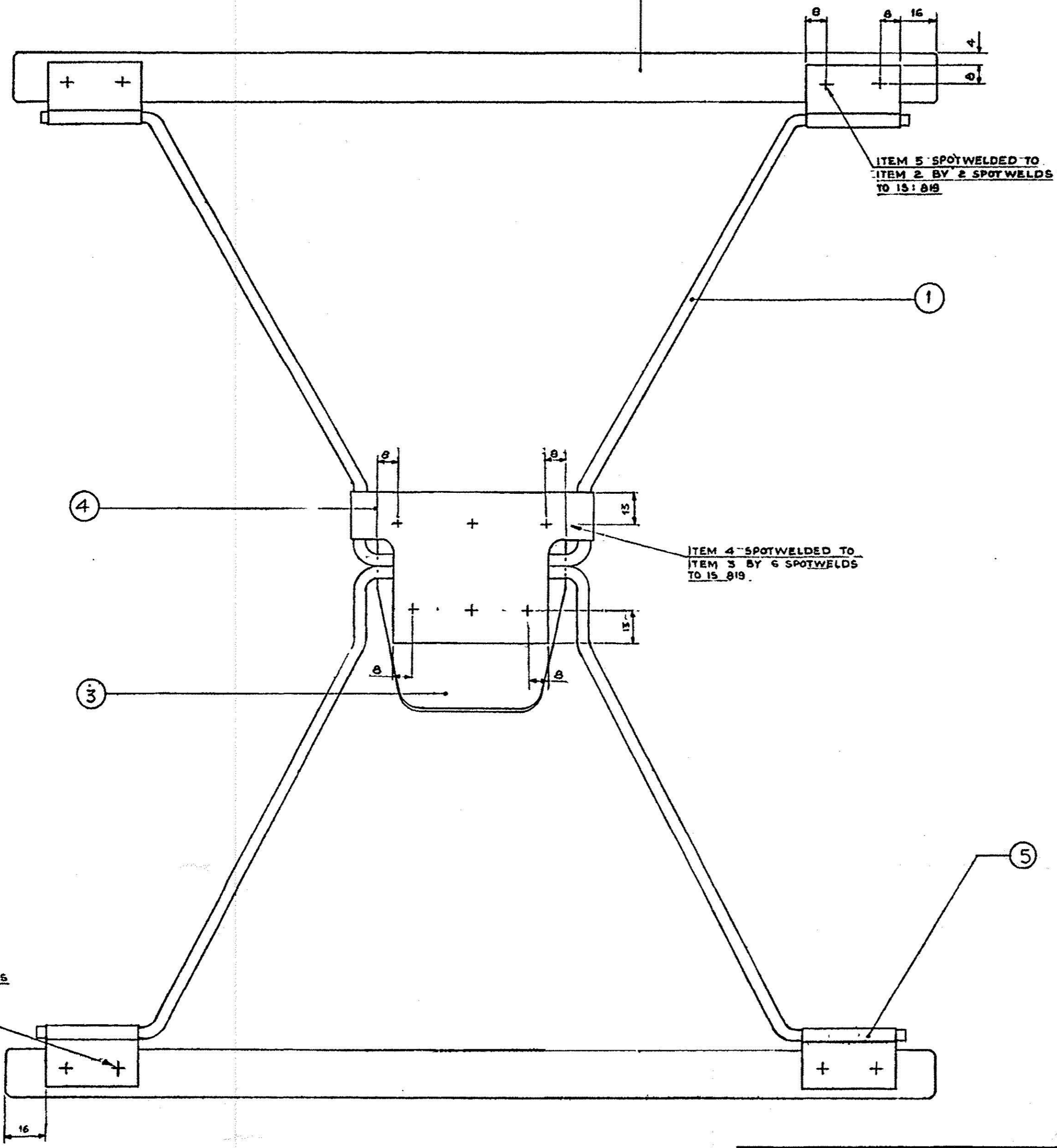

LIST OF COMPONENTS					
ITEM No.	DESCRIPTION	DRG No.	DET No.	PART No.	No OFF
1	LINK	ARDE 2283	9		2
2	HINGE PLATE	ARDE 2283	10		2
3	HANDLE	ARDE 2283	11		1
4	HANDLE PLATE	ARDE 2283	12		1
5	HINGE	ARDE 2283	13		4

DRN	CD	TRD	COMP	ASSY DRG. ARDE 2283, SHT. 4			
	PASSED	SCALE 1:1		DESIGN AUTHORITY			
	APPROVED	EST MASS		ARDE PUNE-411021			
		GAUGE SCHED					
		DATE 28-6-96					
R NO	DATE	AUTHORITY	BRIEF RECORD	ZONE	CD	GO	MATL
					SIGN		
DRG SEALED (PROV)				01 NOV 11	CRE(AA)	PROTECTIVE FINISH	
TITLE				LINK ASSY			
DRG No				ARDE 2283			
DET No 5				SHT. No			
PART No.							
D S CAT No							
AHSP							

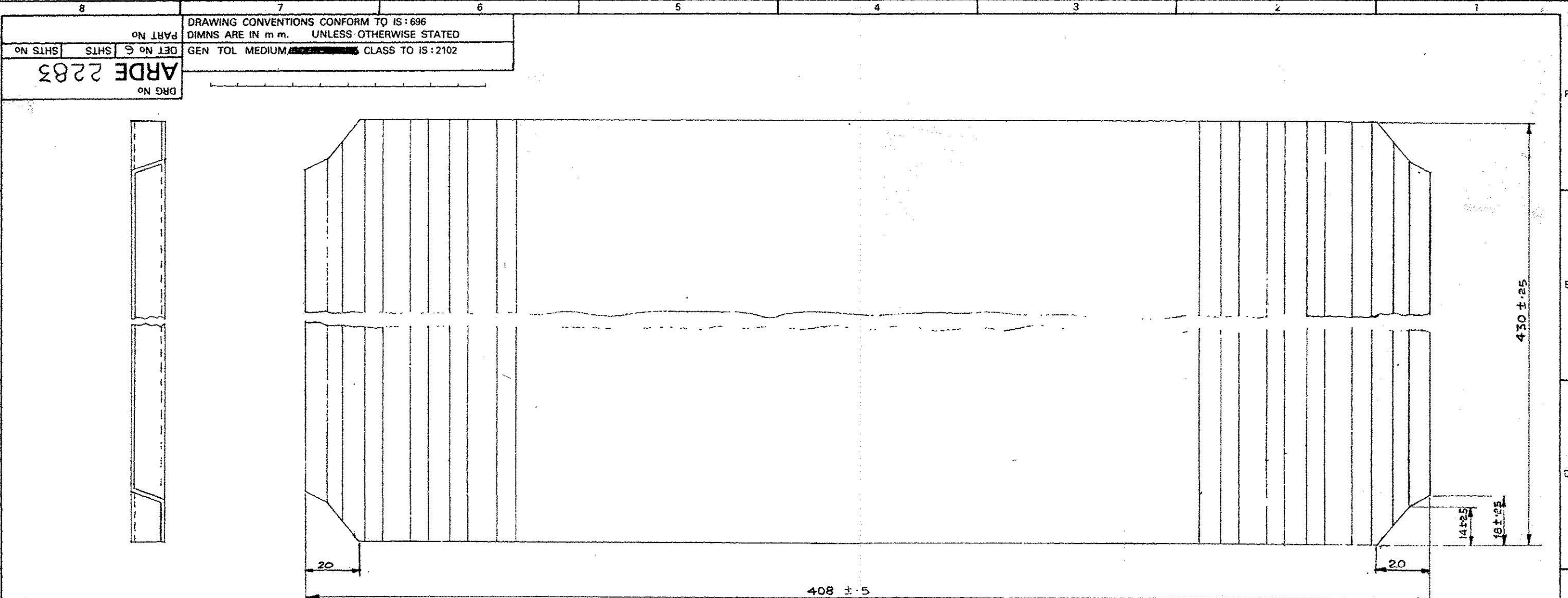

Issue to the GM,
O.P., Dum Dum

उत्पादन तथा निरीक्षण विभाग के द्वारा प्रवाहित
Certified Suitable for quick Manufacture
Inspected
दिनांक: 06/09/18
हस्ताक्षर: [Signature]
पद: Foreman
S No: [Blank]
निर्देशक जनरल अंतराष्ट्रीय विमानतंत्र विभाग
Directorate General of Aeronautical Development
Bengaluru.

NOTE :-
CORRUGATION MUST BE WITHIN
± 0.25 OF THEIR CORRECT
LONGITUDINAL POSITION,

PROTECTIVE FINISH:- PHOSPHATING TO IS: 3618 CLASS 'B'
OILED AND STOVED.

DRN [Signature]	CHD [Signature]	TRD	COMP	ASSY DRG ARDE 2283, SHT 4				
CD	PASSED [Signature]	SCALE 1:1		DESIGN AUTHORITY				
APPROVED	[Signature]	EST MASS:		ARDE PUNE-411 021				
	FOR DIRECTOR	Gauge SCHD						
		DATE 28.6.96						
R NO	DATE	AUTHORITY	BRIEF RECORD	ZONE	CD	GO	MATL STEEL TO SPEC IS: 513 Gd. °0°	
DRG SEALED (PROV)					SIGN		ANNEALED CONDITION	
					CRE (AA)		PROTECTIVE FINISH, AS ABOVE.	

BOTTOM PLATE

DRG No	ARDE 2283	
DET No 6	SHTS	SHT No
PART No		
D S CAT No		
AHSP		

DRAWING CONVENTIONS CONFORM TO IS: 696
 DIMNS ARE IN m.m. UNLESS OTHERWISE STATED
 GEN. TOL. MEDIUM CLASS TO IS: 2102

DRG No. ARDE 2283
 DET No 7 SHTS

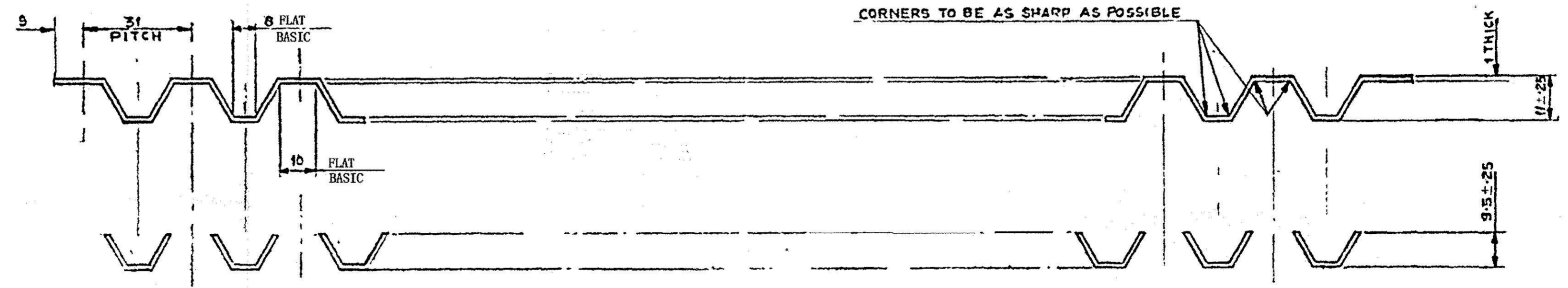
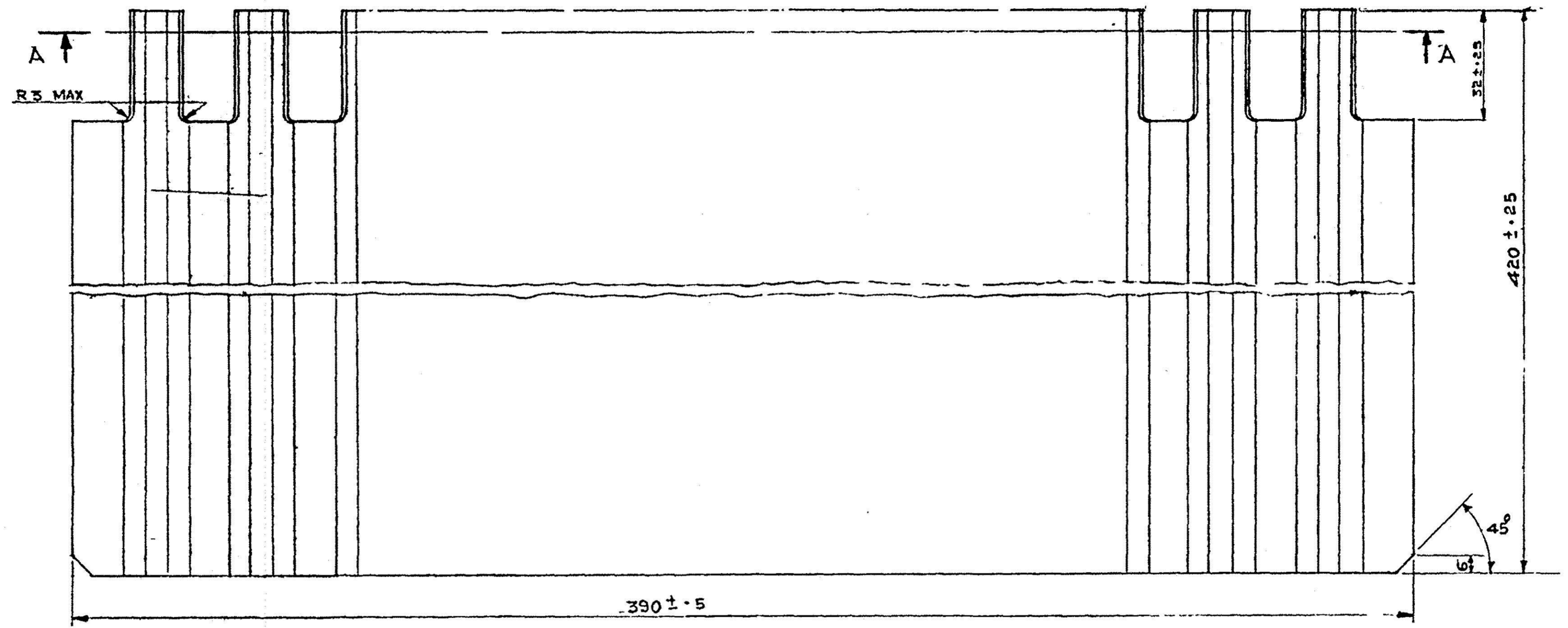

Issue to the GM,
 O.F., Dum Dum
 Inspected Date: 08/09/18
 Signature: [Signature]
 Rank: Foreman

NOTE:-
 CORRUGATIONS MUST BE WITHIN ± 0.25
 OF THEIR CORRECT LONGITUDINAL
 POSITION;

SECTION-AA

PROTECTIVE FINISH:-
 PHOSPHATING TO IS: 3618 CLASS 'B' OILED & STORED

DRN	CHD	TRD	COMP.	ASSY DRG ARDE 2283, SHT 4
CD	PASSED	SCALE: 1:1	DESIGN AUTHORITY	
APPROVED	[Signature]	EST MASS:	ARDE PUNE-411 021	
	FOR DIRECTOR	GAUGE SCHED:		
R. NO.	DATE:	AUTHORITY	BRIEF RECOR.	ZONE
DRG SEALED (PROV)	01 NOV 96	CRE (AA)	MATL. STEEL TO SPEC. IS: 513 Gd 'O'	PROTECTIVE FINISH: AS ABOVE

TOP PLATE

DRG No. **ARDE 2283**
 DET No 7 SHTS SHT No
 PART No.
 D S CAT No.
 A.H.S.P.