

MATERIAL: — ST. STEEL IS 6603:2001
Gr. X 20 Cr 13

TREATMENT -

SURFACE FINISH:

PROTECTIVE FINISH :-

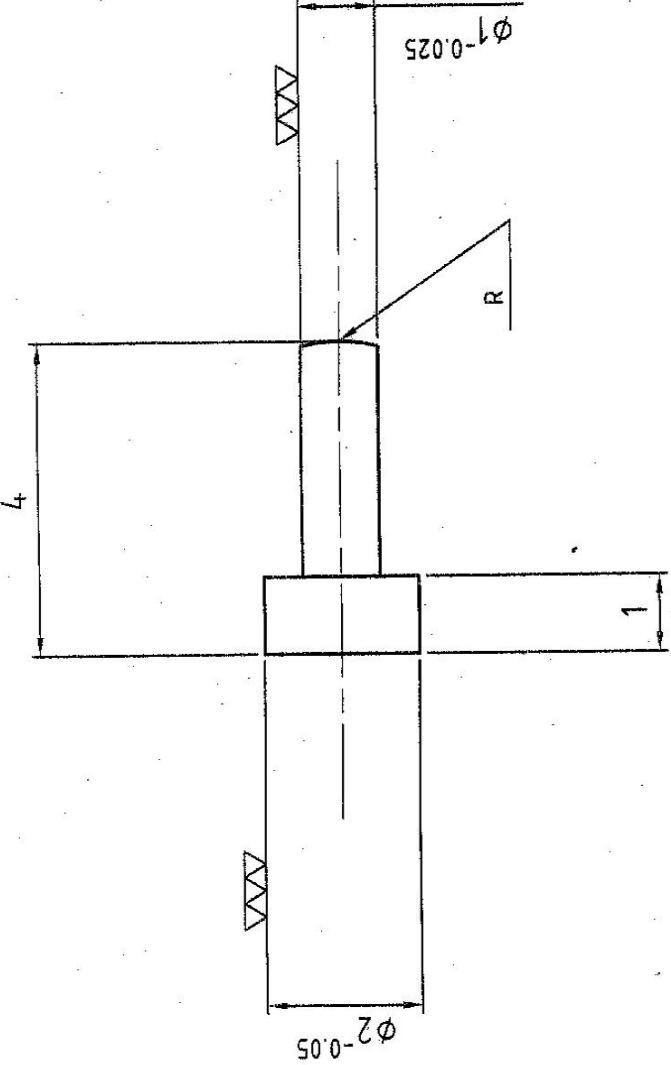
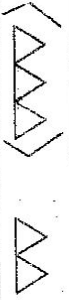

270918

व्यापक हस्त
FOR TRADE ONLY

No. OFF - 02

OLD NO. 036004

ITEM	DESCRIPTION	No. OFF	MATERIAL	REMARKS
LIST OF PARTS				
COMPT. No.		TITLE		
2007		OPTO ELECTRONICS FACTORY DEHRADUN		
ASSY. DRG.		PIN		
RED DOT SIGHT		REF.		
GEN. TOL. IS 2102-m (Pt.-1)		DRG.No. OLF/R&D/RDS/001.04.02.02		
DRAWN	A ₂	16/4	M	
CHECKED	S/D/S	16.4.		
HOS	G/D/S	16.4.		
	NAME	DATE		
AWM/ R&D	<i>[Signature]</i>	M/Yr.	SCALE: 10:1	
	APPROVED	4/07	SHTS. 07 SHT. No. 04	
D.A.No.	DT./SIGN	DESCRIPTION	AMENDMENTS	

ITEM NO	NOMENCLATURE	DRG.NO.	QTY.	MATERIAL	SHFT SIZE
	MOUNT ASSY.	OLF/R&D/RDS/001.06			A 4
	COMPONENT				
1	MOUNT FOR MGL GUN & CARBINE GUN	OLF/R&D/RDS/001.06 .01	01	AL ALLOY IS 736: 83 Gr. 24345 (WP)	A 3
2	HK.SOC.HD.CAP SCREW M4 X 26 LONG	—	01	IS: 2269-81, 8.8 ZINC PLATED CHRO- BLACK	
3	HK.SOC.HD.CAP SCREW M4 X 10 LONG	—	02	IS: 2269-81, 8.8 ZINC PLATED CHROM. BLACK	

270918

ऑप्टिक हेतु
FOR TRADE ONLY

COMPT. No.		ASSY. DRG.		OPTO ELECTRONICS FACTORY DEHRADUN	
2007	GEN. TOL. IS 2102-m (Pt.-1)	RED DOT SIGHT		TITLE	
DRAWN			16.04	MOUNT ASSY.	
CHECKED	<i>[Signature]</i>		16.04	REF. M1	
HOS	<i>[Signature]</i>		16.04	DRG.No.OLF/R&D/RDS/001.06	
	NAME	DATE			
AWM/ R&D	<i>[Signature]</i>	M/YT.	4/2007	SCALE: —	
D.A.No.		DT./SIGN		SHTS. 03 SHT. No. 01	
DESCRIPTION		APPROVED			
AMENDMENTS					

MATERIAL:	TREATMENT HARDNESS:
SURFACE FINISH:	PROTECTIVE FINISH:

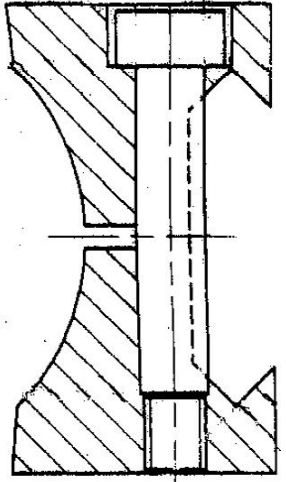
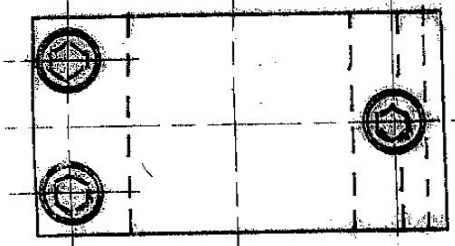
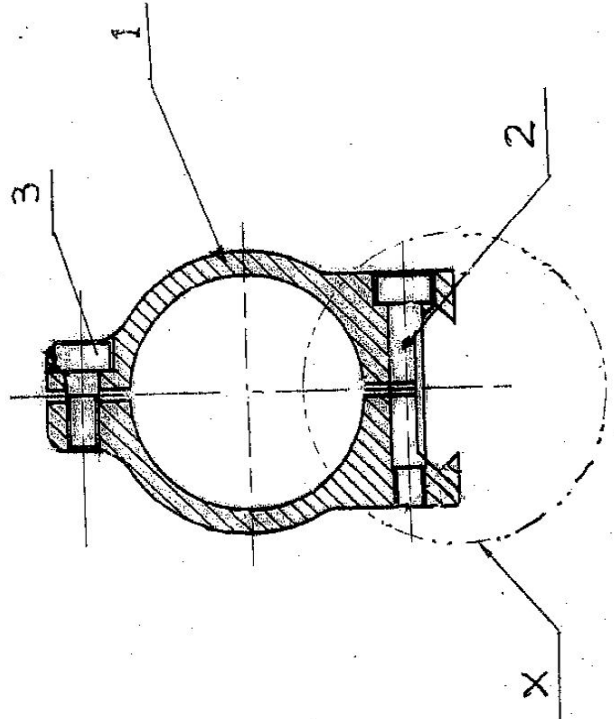

270918

ऑप्टिकल माउंट
FOR TRADE ONLY

VIEW - X
SCALE 2:1

ITEM	DESCRIPTION	No. OFF	MATERIAL	REMARKS
LIST OF PARTS				
2007	OPTO ELECTRONICS FACTORY DEHRADUN			
TITLE		MOUNT ASSY		
REF. OLF/MCP/RDS/99 dt. 13/6/2012		M1		
DRG.No. OLF/R&D/RDS/001-06				
COMPT. No.	ASSY. BRG.	RED DOT SIGHT		
2007	GEN. TOOL IS 2102-# (Pt. -1)			
DRAWN		14.04		
CHECKED		16.04		
HOS		16.04		
A.W.M/ R&D	NAME	DATE	M/Y	APPROVED
D.A.No.	DT./SIGN	DESCRIPTION	AMENDMENTS	

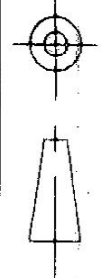

MATERIAL: - SYNTHETIC RUBBER NITRILE BLACK
 BA-3 RHD 51-60 TO BS 275156

TREATMENT -

SURFACE FINISH: 

PROTECTIVE FINISH :-

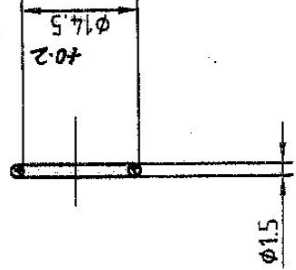
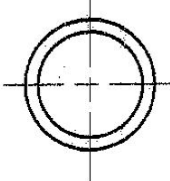

270918
 बंधन हेतु
 FOR TRADE ONLY

No.OFF-02

ITEM	DESCRIPTION	No. OFF	MATERIAL	REMARKS
LIST OF PARTS				
COMPT. No.	ASSY. DRG.	OPTO ELECTRONICS FACTORY DEHRADUN		
2007	RED DOT SIGHT	TITLE		
DRAWN	GEN. TOL. IS 2102-m (PT.-1)	'O' RING		
CHECKED	16/4	REF.		
HOS	16.4	M		
	16.4	DRG.No. OLF/R&D/RDS/001.04.01.02		
	DATE	SCALE: 1:1		
	M/Yr.	SHTS. 04 SHT. No. 04		
AWM/ R&D	NAME			
APPROVED				
DT./SIGN	DESCRIPTION	AMENDMENTS		

SURFACE FINISH: 2.5 (✓)

MATERIAL: AS BELOW

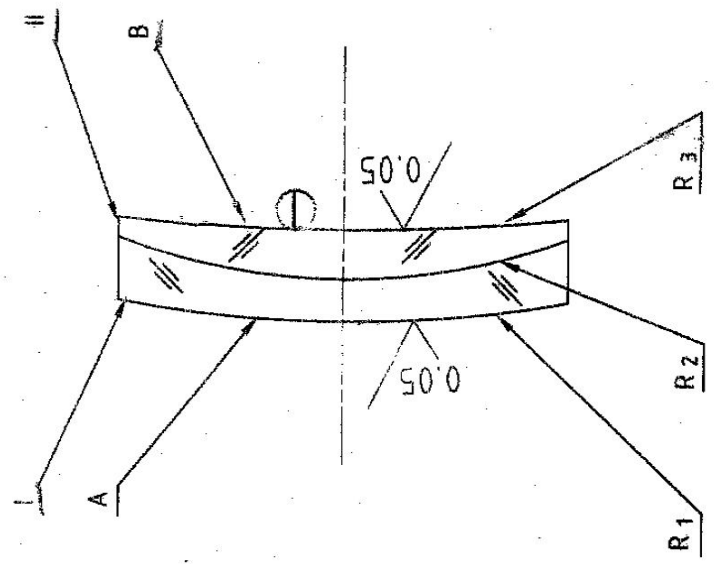

N	3
△ N	0.5
P	IV
△ R	0.02
C	0.01
EFL	5

270918
 OPTO ELECTRONICS FACTORY
 FOR TRADE ONLY

ENS No.	DRAWING No.	EFL	GLASS	R ₁	R ₂	R ₃	C.T.	DIA
I	OLF/R&D/RDS/001.01.11	109.15 108.25	SF-4	81.47 VEX	40.83 CAVE	-	2.7 ± 0.1	φ29 -0.025 -0.085
II	OLF/R&D/RDS/001.01.12	109.15 108.25	BK-7	-	40.83 VEX	14.388 CAVE	3.2 ± 0.1	φ29 -0.025 -0.085

NOTES :-

- (i) ⊗ A & B - A.R. COATING FOR VISIBLE 400 nm. - 700 nm. (R < 0.5%)
 - (ii) ⊕ B - REFLECTION AT 630 - 660 nm. (R > 98%) ± 650 ± 20 nm (R > 70%)
- LENS I & II TO BE GLUED WITH U.V. CEMENT

QTY. PER SET : 01

ITEM	DESCRIPTION	No. OFF	MATERIAL	REMARKS
LIST OF PARTS				
COMP.T. No.	ASSY. DRG. RED DOT SIGHT	OPTO ELECTRONICS FACTORY DEHRADUN		
GEN. TOL. IS 2102-m (Pt. - I)	16-4	TITLE: OBJECTIVE LENSES I & II		
DRAWN	16-4	REF. M 2		
CHECKED	16-4	DRG.No. OLF/R&D/RDS/001.01.11		
NAME	DATE	OLF/R&D/RDS/001.01.12		
M/Yr.	M/Yr.	SCALE: - 1:2		
APPROVED	APPROVED	SHTS. 16 SHT. No. 13		

AMENDMENTS

JE G M/SC AUTHY:- OLF/DP/VC/13D dt. 4.9.2015 COATING AMENDED

DT./SIGN DESCRIPTION

MATERIAL: SYNTHETIC RUBBER NITRILE BLACK
BA-3 RHD 51-60 TO BS 2751:56

TREATMENT

SURFACE FINISH: 

PROTECTIVE FINISH: _____

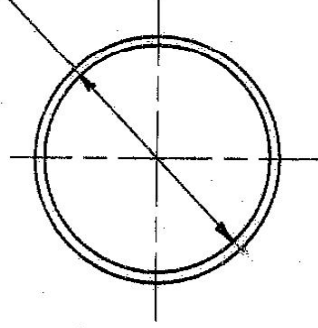

$\phi 25 \pm 0.12$



$\phi 1.0 \pm 0.15$

270918

रहित हेतु
FOR TRADE ONLY

No.OFF-01

ITEM	DESCRIPTION	No. OFF	MATERIAL	REMARKS
LIST OF PARTS				
COMPT. No.	ASSY. DRG.	TITLE		
2007	RED DOT SIGHT	OPTO ELECTRONICS FACTORY DEHRADUN		
DRAWN	GEN. TOL. IS 2102-m (Pt.-1)	16-4	REF. M1	
CHECKED	DATE	16-4	DRG.No. OLF/R&D/RDS/001.01.09	
HOS	NAME	16-4	SCALE: 1:1	
AWM/R&D	M/Yr.	4/12	SHTS. 16 SHT. No. 11	
APPROVED				
AMENDMENTS				
D.A.No.	DESCRIPTION			
DA/94/2015	<p><i>Worship</i></p> <p>JE 4m/8C Dimn. $\phi 25 \pm 0.12$ WAS $\phi 27 \pm 0.2$ & $\phi 15$</p> <p>21/7/2015</p>			

MATERIAL - SYNTHETIC RUBBER NITRILE BLACK
 BA-3 RHD 51-60 TO BS 2751:56

TREATMENT -

SURFACE FINISH: 

PROTECTIVE FINISH :-

0.23 ± 0.2

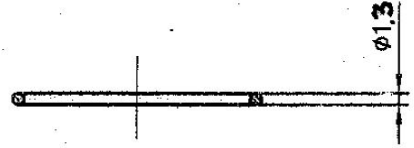
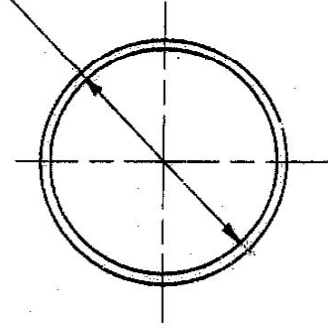

270918

व्यापार हेतु
 FOR TRADE ONLY

No: OFF-01

ITEM	DESCRIPTION	No. OFF	MATERIAL	REMARKS
LIST OF PARTS				
COMPT. No.	ASSY. DRG.	TITLE		
	RED DOT SIGHT	OPTO ELECTRONICS FACTORY DEHRADUN		
2007	GEN. TOL. IS 2102-m (Pt.-1)	ORING		
DRAWN	<i>Kg</i> 16.4	REF. M		
CHECKED	<i>Sh om</i> 16.4	DRG.No. OLF/R&D/RDS/001.01.13		
HOS	<i>Sh om</i> 16.4	SCALE: 1:1		
	NAME	DATE	SHTS. 16 SHT. No. 14	
		M/Yr.		
AWM/R&D	<i>Sh</i>	4/87		
APPROVED				
D.A.No.	DT./SIGN	DESCRIPTION	AMENDMENTS	

MATERIAL: SYNTHETIC RUBBER NITRILE BLACK
BA-3 RHD 51-60 TO BS 27515C

TREATMENT -

SURFACE FINISH: 



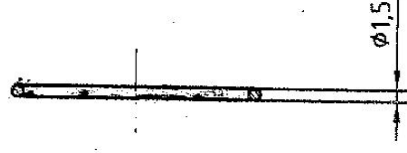
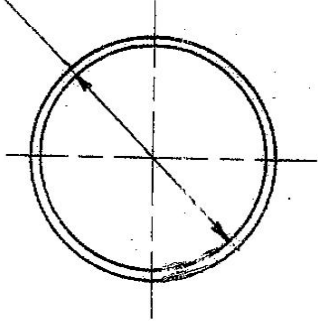

PROTECTIVE FINISH -

076/02



270918
बिप्लव रेड
FOR TRADE ONLY

No. OFF-01

ITEM	DESCRIPTION	No. OFF	MATERIAL	REMARKS
LIST OF PARTS				
COMPT. No.	ASSY. DRG.	OPTO ELECTRONICS FACTORY DEHRADUN		
2007	RED DOT SIGHT	TITLE		
	GEN. TOL. IS 2102-m (Pt.-1)	REF. M J		
DRAWN	 16.4	ORING		
CHECKED	 16.4	DRG.No. OLF/R&D/RDS/001.01.016		
HOS	 16.4	DATE		
	NAME	M/YT		
		4/82		
AWM/ R&D	APPROVED			
D.A.No.	DT./SIGN	DESCRIPTION	SCALE: 1:1	SHTS. 16
AMENDMENTS				EHT. No. 16



MATERIAL: - SYNTHETIC RUBBER NITRILE BLACK
 BA-3 RHD 51-60- TO BS 275156

TREATMENT -

SURFACE FINISH: 

PROTECTIVE FINISH :-

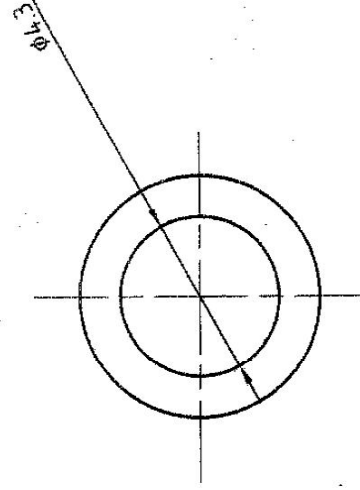

2 / 0.918

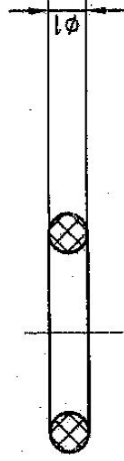

ऑप्टिक हेतु
 FOR TRADE ONLY

No. OFF-02

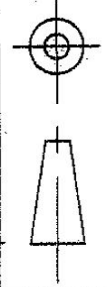
ITEM	DESCRIPTION	No. OFF	MATERIAL	REMARKS
LIST OF PARTS				
COMPT. No.	ASSY. DRG.	OPTO ELECTRONICS FACTORY DEHRADUN		
2007	RED DOT SIGHT	TITLE		
	GEN. TOL. IS 2102-m (Pt. -1)	REF.		
DRAWN	<i>As</i>	16/4	M	
CHECKED	<i>GT-11 om</i>	16.4		
HOS	<i>GT-11 om</i>	16.4		
	NAME	DATE		
	<i>As</i>	<i>16/4</i>		
AWM/ R&D	APPROVED	M/YC.	SCALE: 	
		<i>16/07</i>	SHTS. 07 SHT. No. 05	
D.A.No.	DESCRIPTION	DRG.No. OLF/R&D/RDS/001.04.02.03		
AMENDMENTS				