

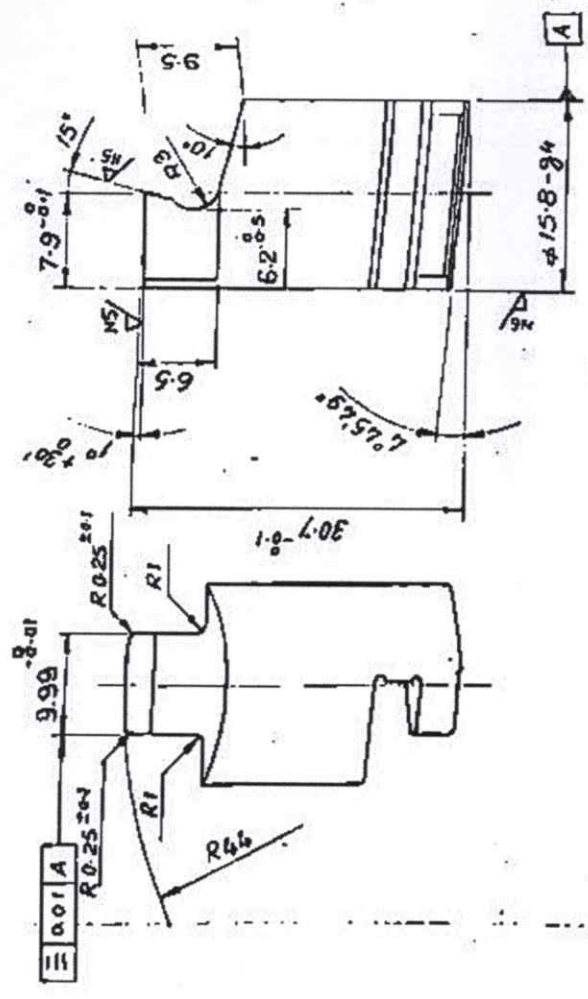

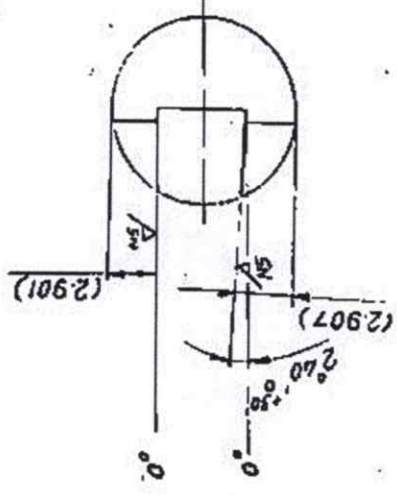

REV 224N  
DRC No. **LGT.0364/2**

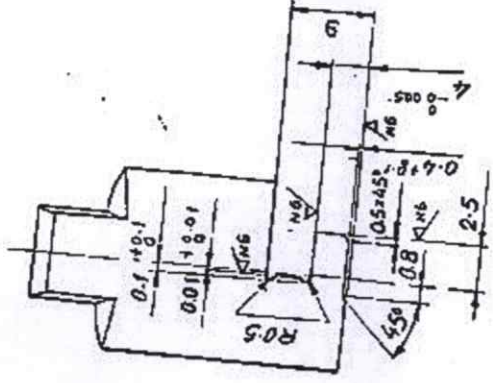

NOTE:  
ALSO TO BE USED AGAINST  
REQ. No.58/IFG/A/2K, dt 20-9-2k.



N9    

ALSO TO BE USED AGAINST REQ No. IFG/RS/193, dt 13-10-23

RIFLING CUTTER		253 H-TAG.		AS SHENN		66 REC. PWR	
REV	DATE	REV	DATE	REV	DATE	REV	DATE
1		1		1		1	
ITEM NO. 1986				DATE 12-1-58			
QTY 100				BY [Signature]			
DESCRIPTION RIFLING CUTTER				FOR [Signature]			
MATERIAL				GRADE			
TOLERANCE				FINISH			
MACHINE				OPERATOR			
INSPECTOR				DATE			
REMARKS				SIGNATURE			
FOR [Signature]				DATE 12-1-58			
PROJECT NO.				32-399-1673			
DRAWING NO.				LGT-0364/2			

FOR RIFLING CUTTER  
IFG. MK. II

BY [Signature]  
GUN CARTRIDGE FACTORY, JADALPUR

NOTE:  
THIS DRG. IS MADE AS PER SAMPLE

φ15.8-84	-0.006
NOM. SIZE & FIT	-0.011
DEVIATION	