

MATERIAL: _____	TREATMENT: _____
SURFACE FINISH: _____	HARDNESS: _____
_____	PROTECTIVE FINISH: _____

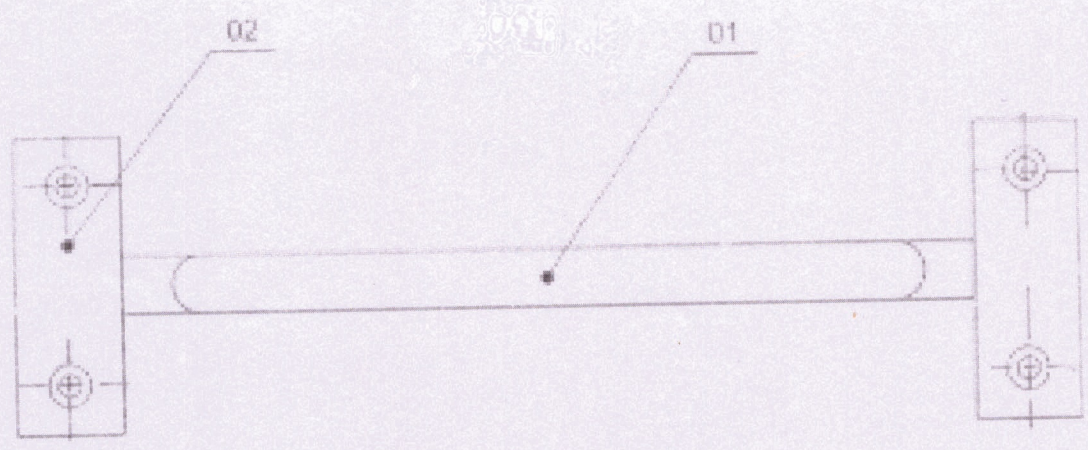

FOR TRADE ONLY
 Date of Issue 22/07/20
Raj

NOTE -
 1 UNSPECIFIED TOLERANCES ON EXTERNAL SIZE INTERNAL SIZE & OTHERS ARE H12 H12 & ±IT12/3 RESPECTIVELY

व्यापार हेतु
 For Trade only
 09 JUL 2020

02	CLAMP	
01	HANDLE	
ITEM	DESCRIPTION	REMARKS

COMPT NO		ASSY DRG	OPTO ELECTRONICS FACTORY	
		PACKING	DEHRADUN	
		BOX TYP	TITLE	
			HANDLE WITH CLAMPS	
DATE	AS STATED	REF ASSY-1		
DRAWN	<i>[Signature]</i>	LT. RE. DUF/ASSY-1/TXP/16		M
CHKD	<i>[Signature]</i>	DATE 22/07/2020		
JWM	<i>[Signature]</i>	DRG No OLF/STD/244		
	NAME	DATE	SCALE - 1:1	
DA No	DATE/SIGN	DESCRIPTION	SH TS 03	SH No 01
AMENDMENTS			APPROVED	

MATERIAL - STEEL 45-C 20 OF IS 1570-1979	TREATMENT - _____ HARDNESS - _____
SURFACE FINISH - 	PROTECTIVE FINISH - RED OXIDE

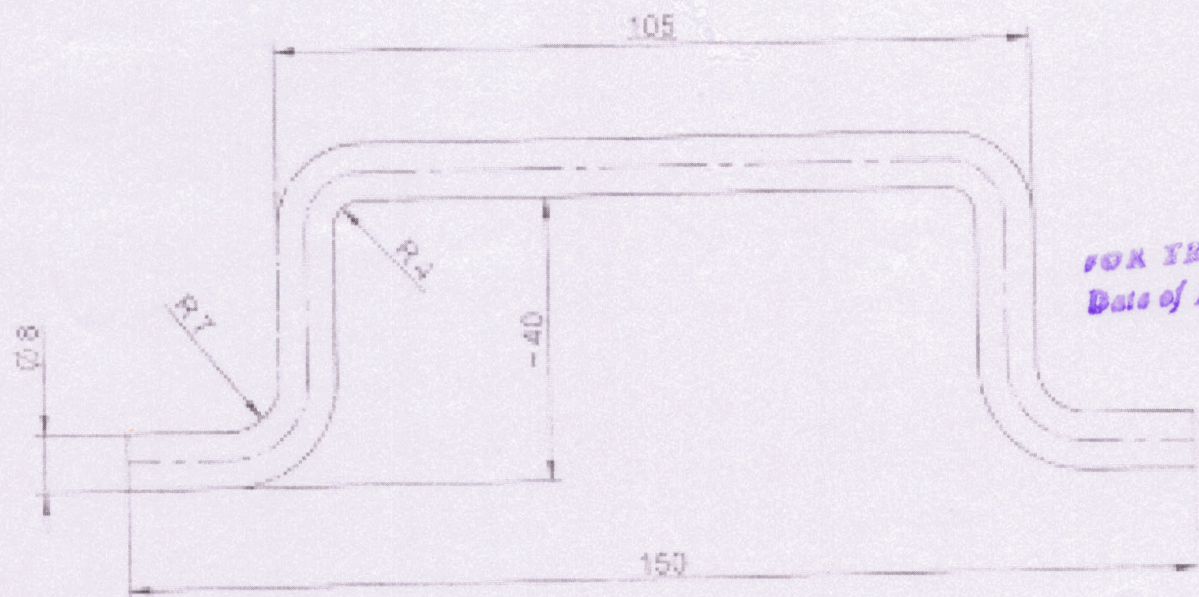

FOR TRADE ONLY
Date of Issue 20/01/21
By: *[Signature]*

NOTE
UNSPECIFIED TOLERANCES ON EXTERNAL SIZE INTERNAL SIZE OTHERS ARE H11/D8 & F11/D10 RESPECTIVE

व्यापार हेतु
For Trade only
09 JUL 2020

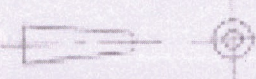
ITEM	DESCRIPTION	No OFF	MATERIAL	REMARKS
LIST OF PARTS				
CONF NO	ASSY DRG PACKING BOX TRF	OPTO ELECTRONICS FACTORY DEHRADUN		
DATE	AS STATED	TITLE: HANDLE		
DRG	<i>[Signature]</i>	ITEM NO - 01		
QTY	<i>[Signature]</i>	REF		M
NAME	DATE	DRG No. - OLF/STD/244		
DA No	DATE/SIGN	DESCRIPTION	DIV OFF	MYEAR
AMENDMENTS		APPROVED		SCALE 1:1 SHTS 03 / SH No 03

MATERIAL - STEEL SHEET G.I. OF IS 513
 ALT. MATE. STL SHEET G.I. OF IS 513

TREATMENT -
 HARDNESS -

SURFACE FINISH - 

PROTECTIVE FINISH - RED OXIDE

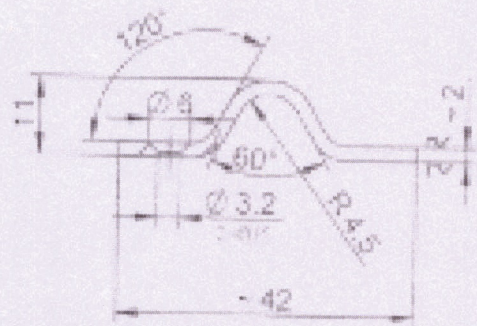
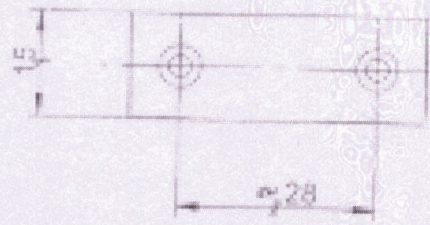

FOR TRADE ONLY
 Date of Issue 24/07/20 *RJ*

09 JUL 2020

NOTE -
 1. UNSPECIFIED TOLERANCES ON EXTERNAL SIZE INTERNAL SIZE & OTHERS ARE ± 0.1 & ± 0.05 RESPECTIVELY.
 2. REMOVE SHARP EDGES.

व्यापार हेतु
 For Trade only

ITEM	DESCRIPTION	No OFF	MATERIAL	REMARKS
------	-------------	--------	----------	---------

LIST OF PARTS				
COMPT NO	ASSEMBLY DRG	OPTO ELECTRONICS FACTORY		
	PACKING BOX TYP	DEHRADUN		
2016	AS STATED	CLAMP		
DRAWN	<i>[Signature]</i>	ITEM NO - 02		
CHD	<i>[Signature]</i>	M		
JWM	<i>[Signature]</i>	ORG. No. - OLF/STD/244		

DA No	DATE SIGN	DESCRIPTION
-------	-----------	-------------

AMENDMENTS

APPROVED		SCALE - 1:1
		SHTS 03 SH No 03