

S.NO.	DRAWING NO.	DESCRIPTION	PART NO.	NO. REQD.	I.A.F SEC. REF. NO.	MATERIAL	SPECIFICATION	FOR S.NO.	ISSUE	REMARK
1	ARM 1519 D1	GENERAL ARRANGEMENT							4	
2	" " D-2/1	DETAILS OF ITEM NO. 1		1		AS STATED IN DRG.			3	
3	" " D-3/2	" " " " 2		1		VULCANISED NATURAL RUBBER			3	
	" " D-3/3	" " " " 3		2		M.S. SHEET			3	
	" " D-3/4	" " " " 4		4		"			3	
	" " D-3/5	" " " " 5		4		"			3	
	" " D-3/6	" " " " 6		4		"			3	
	" " D-3/7	" " " " 7		4		"			3	
	" " D-3/8	" " " " 6		4		"			3	
	" " D-3/9	" " " " 9		4		"			3	
4	" " C-4/10	" " " " 10		1		M.S. SHEET WOOD PLYWOOD			2	
	" " C-4/11	" " " " 11		2		M.S. SHEET			2	
	" " C-4/12	" " " " 12		1		"			2	
	" " C-4/13	" " " " 13		1		WOOD & M.S.			2	
	" " C-4/14	" " " " 14		2		COTTEN AND BRASS SHEET			2	
	ND - 15	M.S. SHEET 1053X381X0.8THK		4		M.S. SHEET	IS:513 Gd.'D'		1	
5	ARM 1519 C-5	METHOD OF PAINTING & STENCILLING		-					2	
6	" " B-6	DETAILS OF ITEM NO 13		1		HARD WOOD & M.S.			2	
7	ARM 1519 A7	RUBBER PLUG		1		NEOPRENE RUBBER	IND/ME/884 (PROV.) CLASS C-3		1	

COMPILED	SL
CHECKED	SL
TRACED	<i>Blashed</i>
CHECKED	<i>@mam</i>
PASSED	
APPROVED	<i>SL</i>

**SCHEDULE FOR  
CONTAINER (FOR TAIL UNIT No.1111)**

SIGN		DATE	ISSUE	ALTERATION	ASSYDRG.NO.	FILE NO.	SHEET NO.	NO OF SHEET
<i>Y.K.</i>	11-11-08	2	DRG. AMENDED VIDC AL No. 26/2008		ARM 1519.D-1		1	1
	8 <sup>06</sup> / <sub>05</sub>	1	ORIGINAL					

DRG.No. **ARM 1519** SCHEDULE  
 1 1

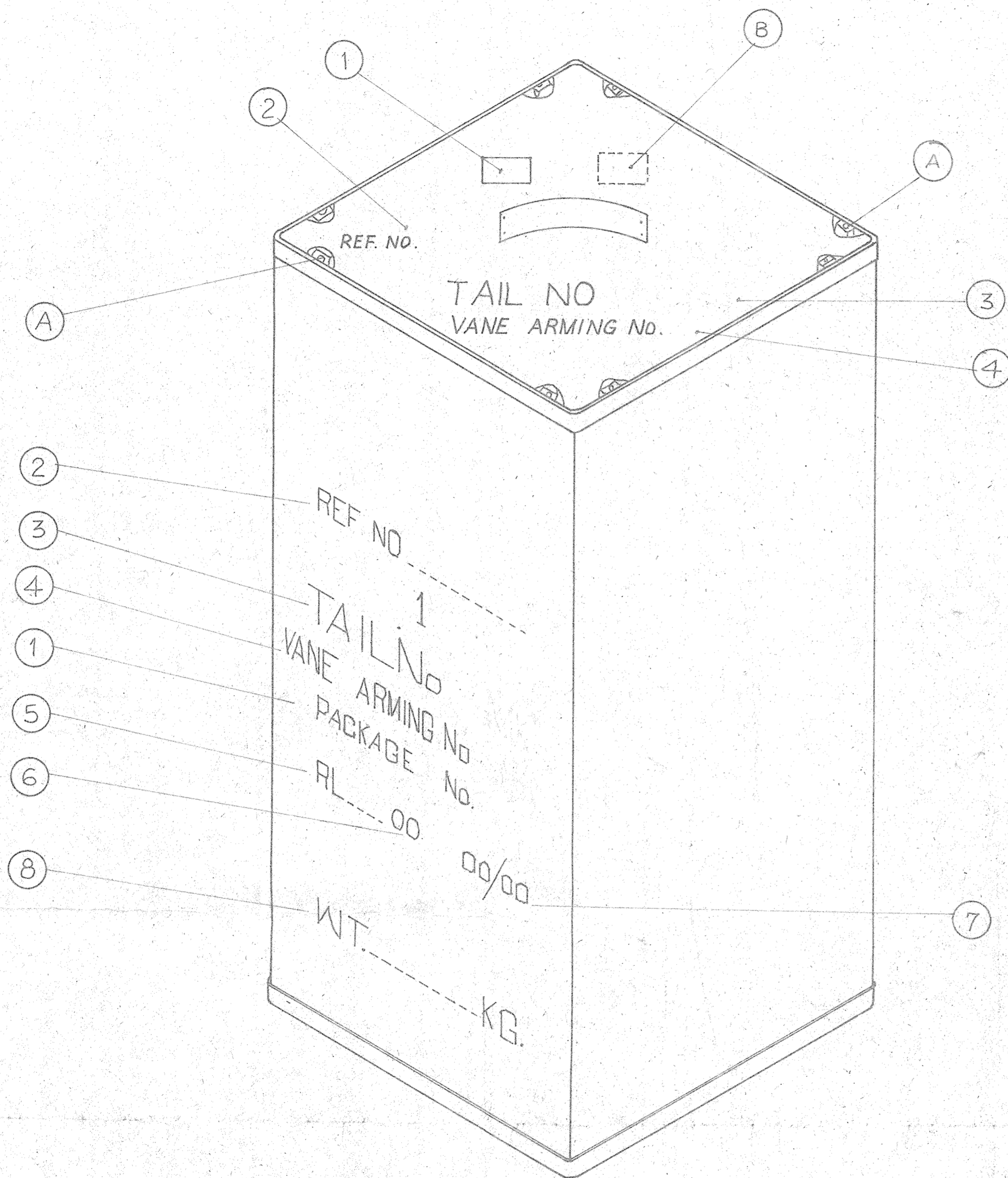

**GENERAL NOTES**

- THE NUMBER OR LETTER IN CIRCLE DE NOTES ITEM IN COLUMN.
- (a) PRIMER PAINT TO BE PAINTED INTERNALLY AND EXTERNALLY WITH ONE COAT OF READY MIXED PAINT AIR DRYING MATT. FOR GENERAL PURPOSE RED OXIDE ISC 446 TO IS: 5, BRUSHING/SPRAYING TO SPECN IS: 168
- (b) FINISH PAINT TO BE PAINTED INTERNALLY AND EXTERNALLY WITH ONE COAT OF READY MIXED PAINT, SEMI GLOSSY/MATT FINISH OLIVE GREEN TO SPECN IS: 168 WITH ISC SHADE 220 OF SPECN IS: 5

ALL STENCILLING TO BE IN 13mm. LETTERS UNLESS OTHER WISE STATED WITH YELLOW PAINT P.F.U. AMMUNITION MARKING TO SPECN. IND/ME/439 TO TINT NO 356 OF I.S.-5 OF 1961 ON TOP AND SIDE AS SHOWN ON DRAWING.

WHEREVER SPECIFICATION HAVE BEEN QUOTED ONLY LATEST ISSUE IMPLIES,

**STENCILLING INSTRUCTIONS**

1. PACKAGE NO.
2. SECTION / REFERENCE NO. AS APPLICABLE
3. NO. & MK. OF TAIL AS APPLICABLE (38mm LETTER)
4. NO & MK. OF VANE ARMING AS APPLICABLE.
5. SERIAL NO. OF TAIL.
6. MANUFACTURER'S INITIALS OR RECOGNISED TRADE MARK.
7. DATE OF PACKING (MONTH AND LAST TWO FIGURES OF YEAR)
8. WEIGHT OF FILLED BOX IN KG (25mm LETTER).

**LABELLING INSTRUCTIONS**

INSPECTION LEAD SEAL.  
PACKER'S LABEL L 566 B TO BE AFFIXED TO THE UNDERSIDE OF THE LID AT PLACE SHOWN.

**NOTE:-**

ALL LABELS TO BE COATED WITH APPROVED VARNISH LABEL AMMUNITION AFTER DRYING.

DIMNS. IN mm.

<b>DRAWN BY</b> I.O.F.E. AIR FORCE DRAWING OFFICE KHAMARIA	<b>DRAWN</b> <i>Santosh</i>
<b>ISSUED BY</b> D.G.A.Q.A. MIN. OF DEF. NEW DELHI	<b>CHECKED</b> <i>Santosh</i>
	<b>TRACED</b> <i>Santosh</i>
	<b>CHECKED</b> <i>Smrity</i>
	<b>PASSED</b>
	<b>APPROVED</b>

**CONTAINER FOR  
(TAIL UNIT No 1111)  
METHOD OF PAINTING & STENCILLING**

MATL.	SPEC.	FINISH	ASSY. DRG. NO.	SCALE	MOD	DATE	ISSUE NO.	ALTERATION
I.A.F. SEC. REF. NO.				1/5		8 5 05	1	
PART. NO.				DRG. NO.				
SCHED. NO.				ARM. 1519 c 5				
FILE. NO.				SHT. NO.	5	NO. OF SHTS.	7	

18 02 06	2	DRG. AMENDED VIDE AL. No 3/2006
----------	---	---------------------------------





FIRST ANGLE PROJECTION

13/A

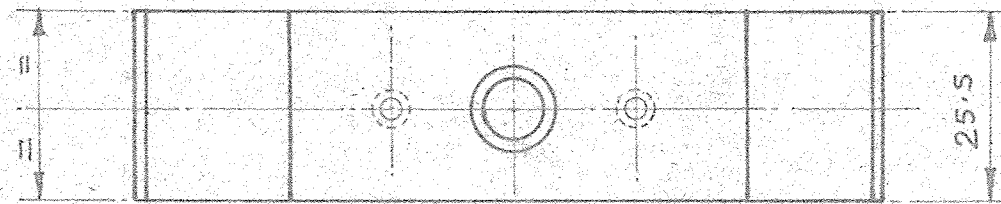
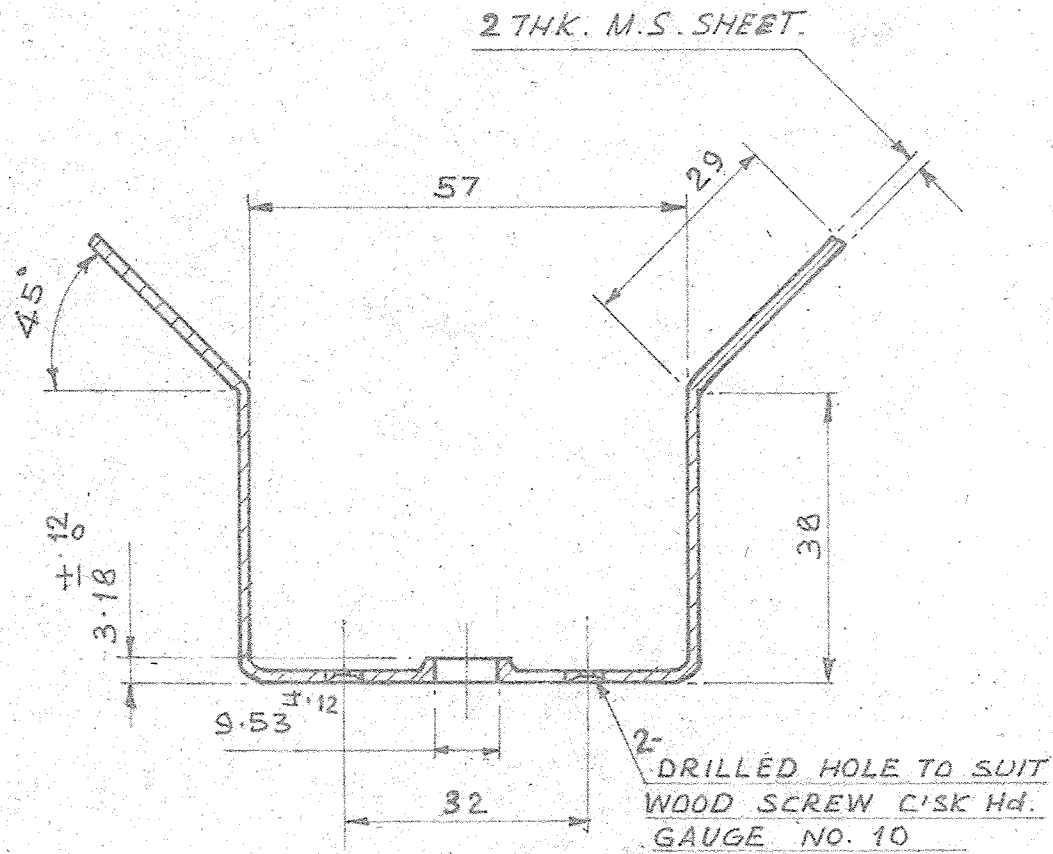

**MATL:-** M.S. TO IS: 1079 St 34 HOT ROLLED & ANNEALED  
OR IS: 513 Gd D COLD ROLLED & ANNEALED  
FINISH- PHOSPHATED TO SPECN. IS: 3618 CLASS B.  
NO. OFF - 1 PER SET.

13/B

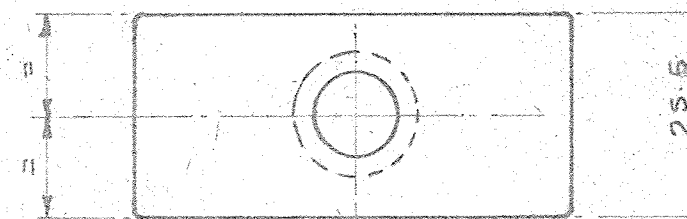
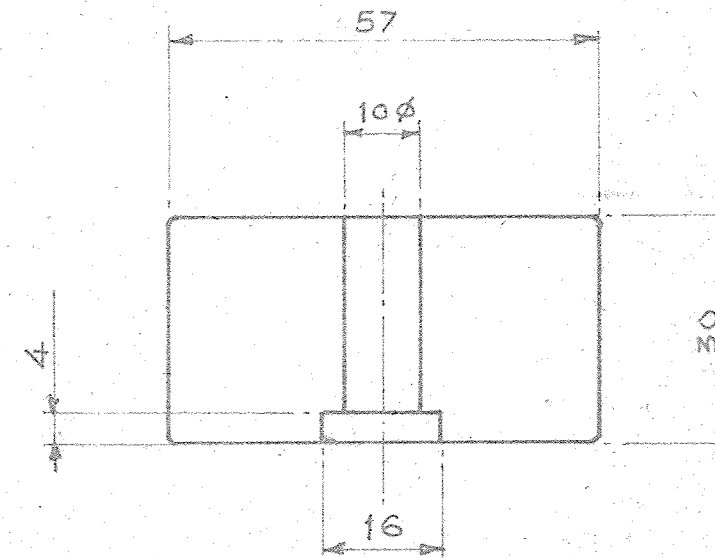

**MATL:-** HARD WOOD, ONLY THE SPECIES OF TIMBER SHOWN  
IN APPENDIX 'A' IND/ME/883, WOOD SHOULD BE COATED  
ALL OVER WITH SHELLAC VARNISH. APC-224 OR  
APC-225 TO SPECN JSS: 1-63-11

No OFF:- 1 PER SET

FOR ASSLY. OF 13/A 13/B REF. ARM 1519 C4 ITEM 13

DIMENSIONS IN mm.

DRAWN BY	DRAWN	Santosh
D&P. DRG. OFFICE	CHECKED	
&	TRACED	Santosh
ISSUED BY DGQA	CHECKED	
MINISTRY OF DEFENCE	PASSED	
GOVT. OF INDIA	APPROVED	

TITLE :-

**CONTAINER**  
(FOR TAIL UNIT NO. 1111)

AS STATED	AS STATED	ARM 1519 C4	15/06/09	2	DRG. AMENDED VIDE AL. No. 9/2006
MATL.	SPECN.	FINISH	SCALE	MOD	DATE
I.A.F. SEC. REF. NO.	ASSEMBLY DRG. NO.		15/06/09	1	ORIGINAL
PART NO.			DRG. No.		
SCHD. NO.	ARM. 1519 SCHD.		ARM 1519 B6		
FILE NO.			SHEET NO	6	NO OF SHEET 7

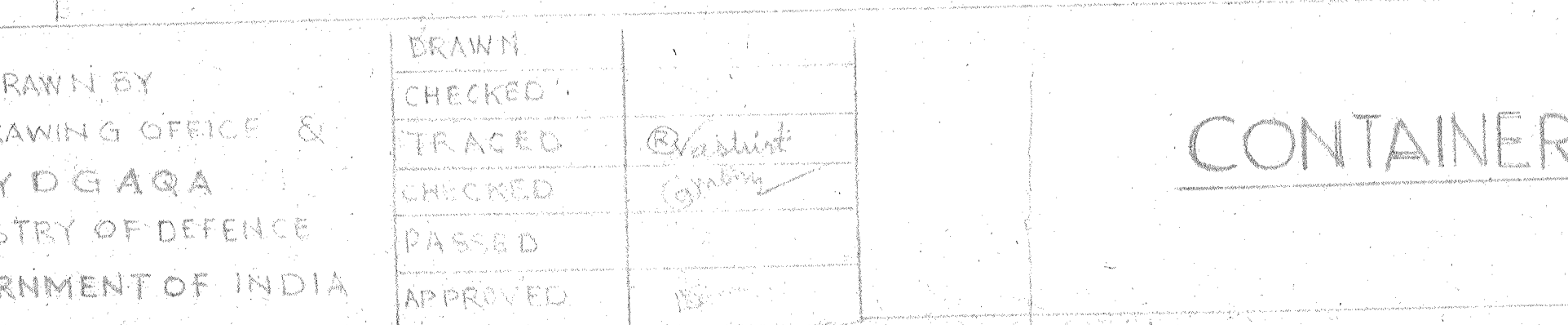
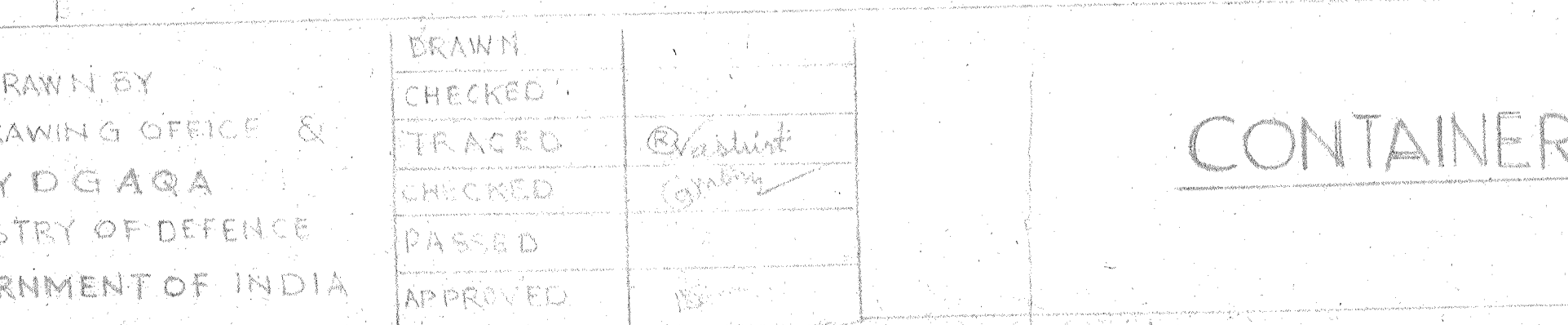
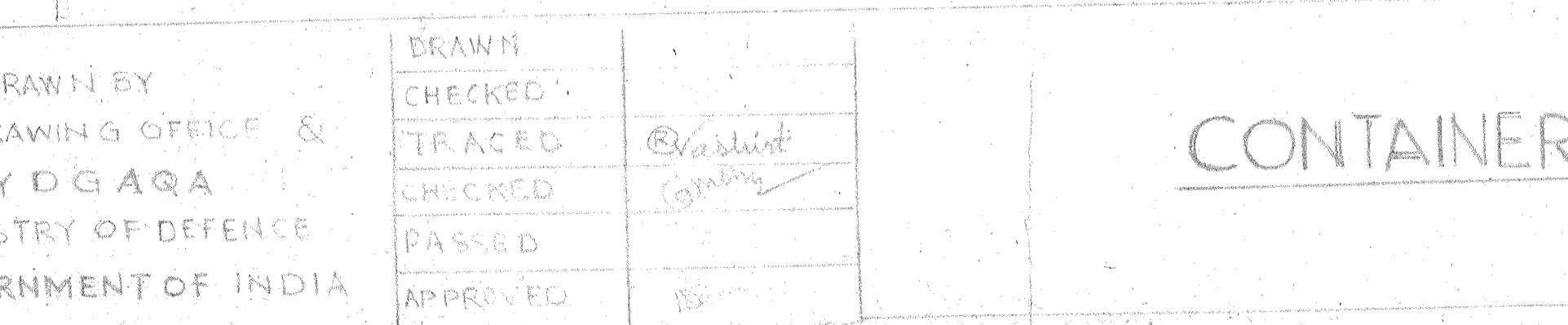
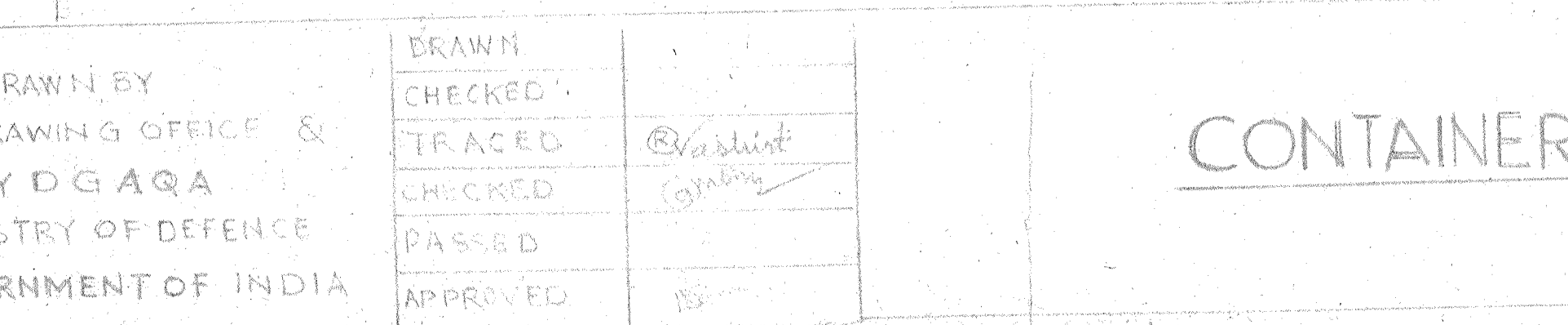
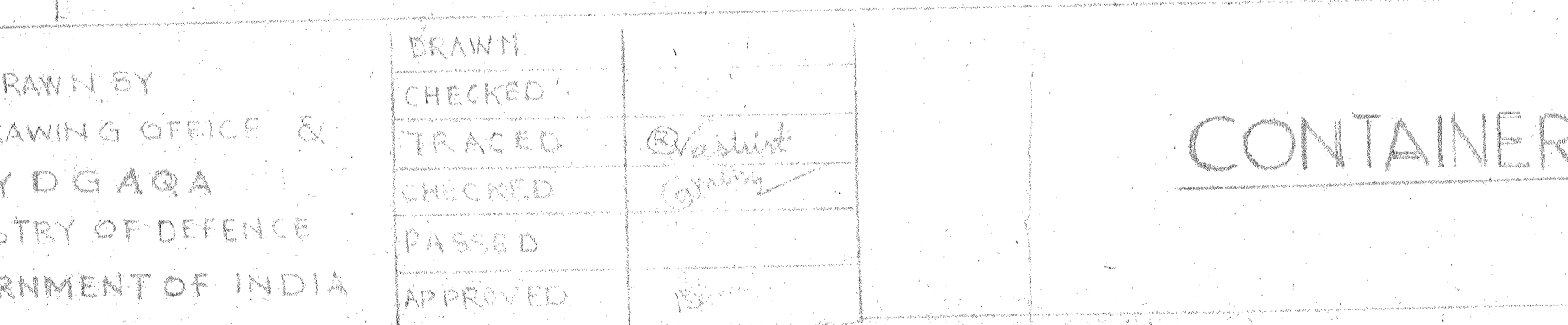
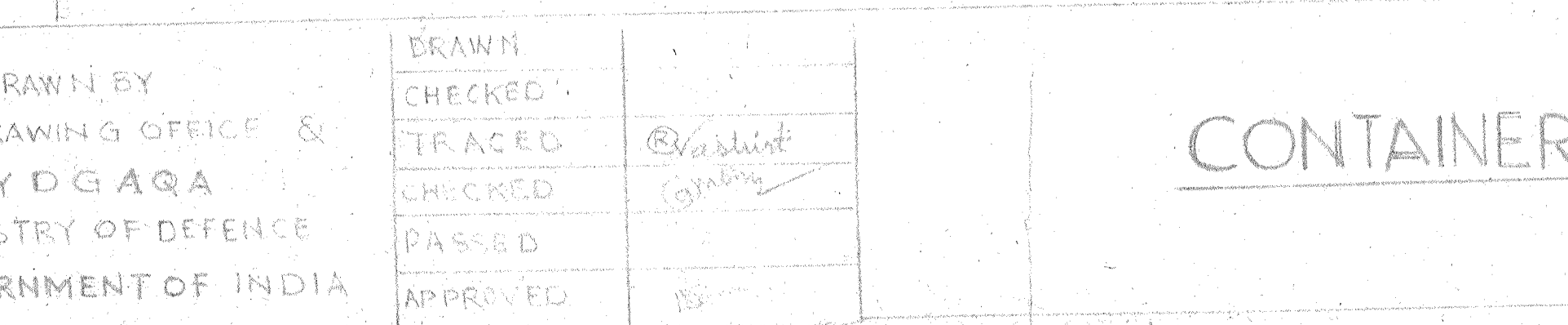
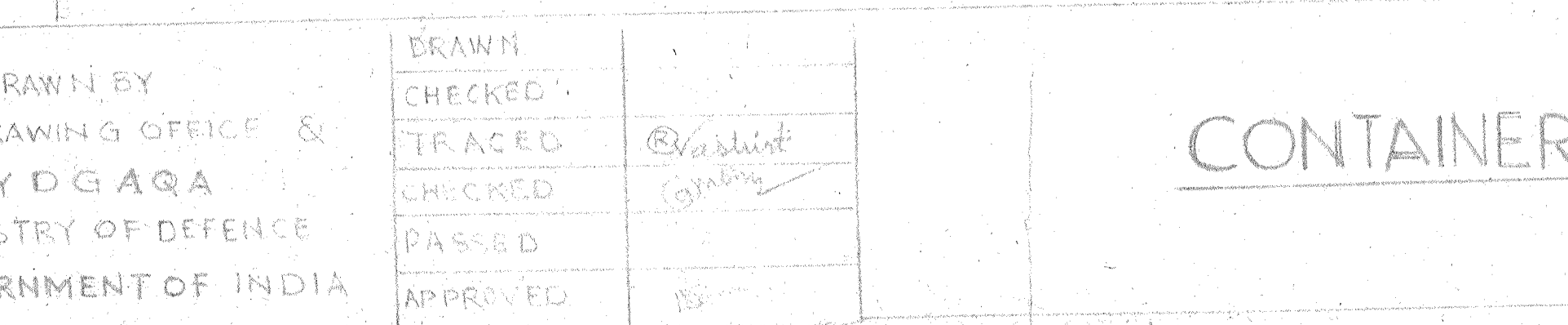
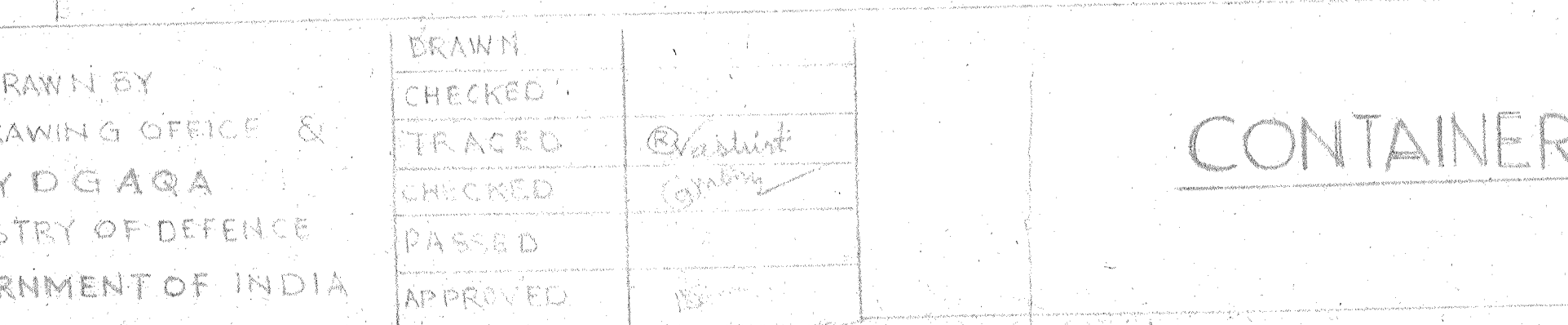
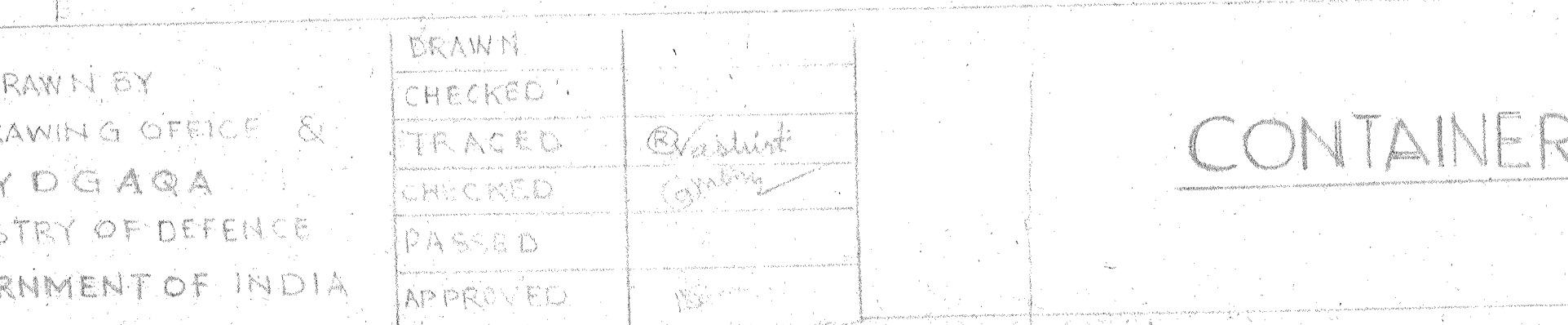
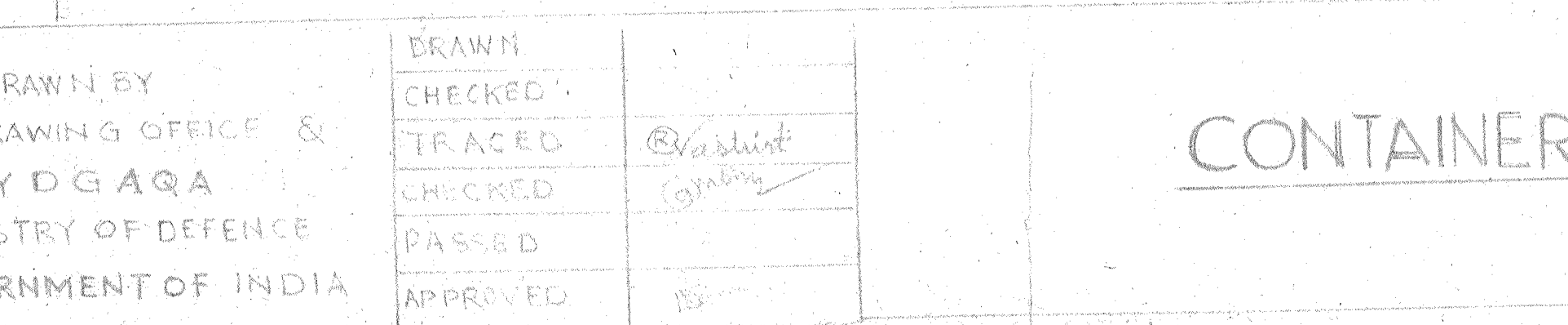
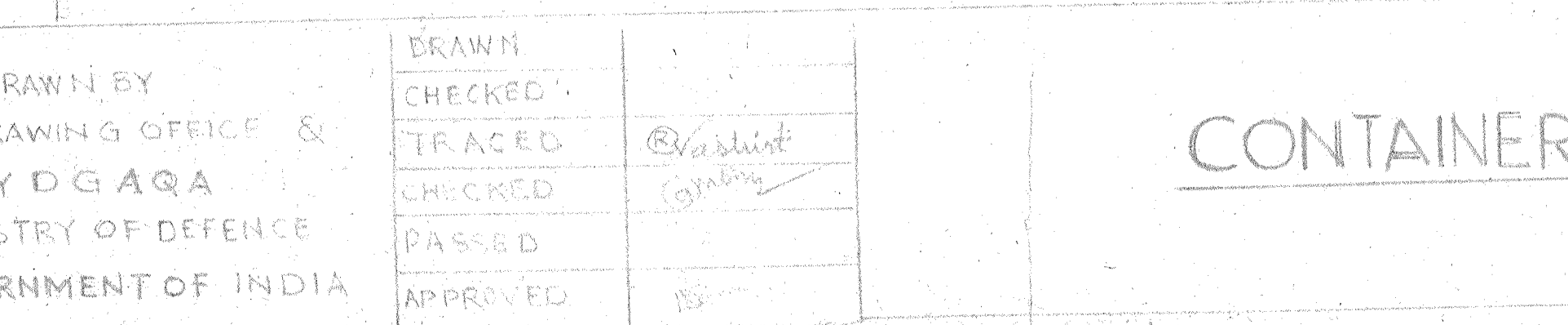
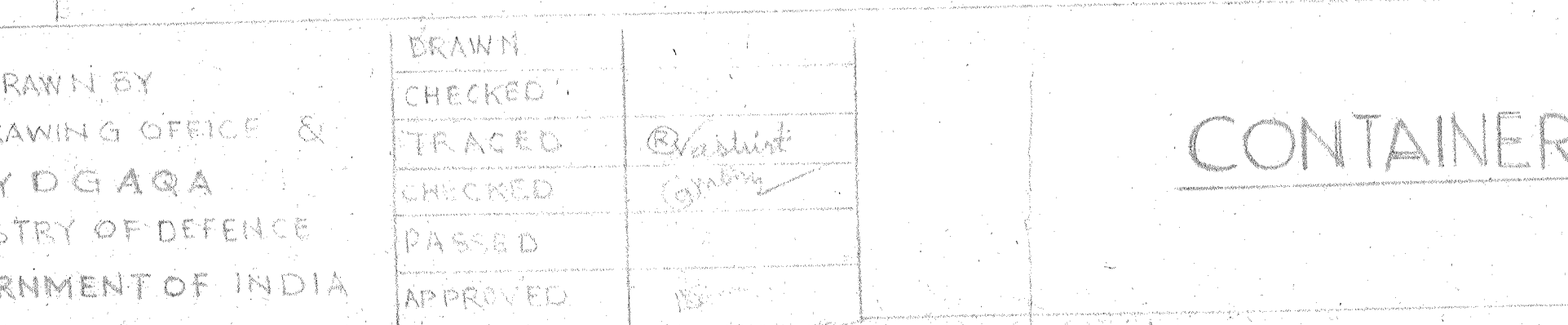
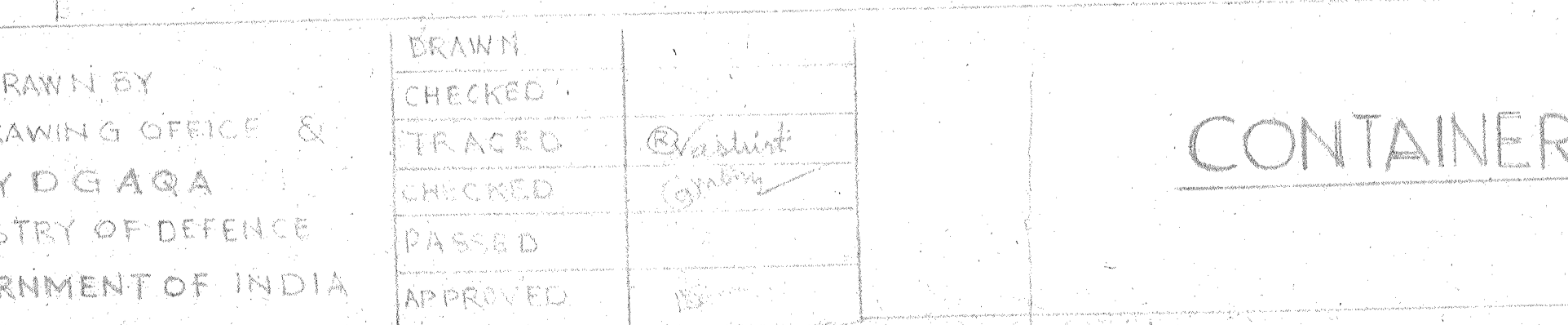
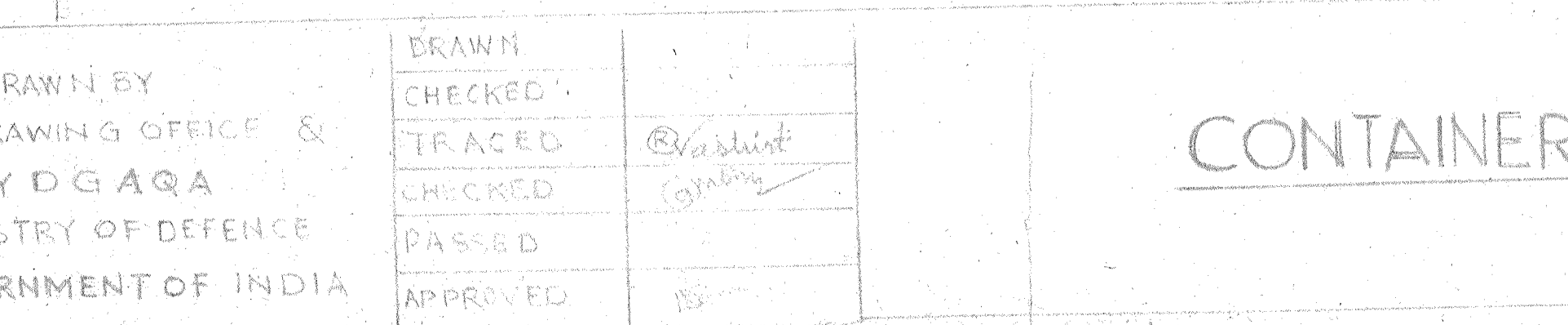
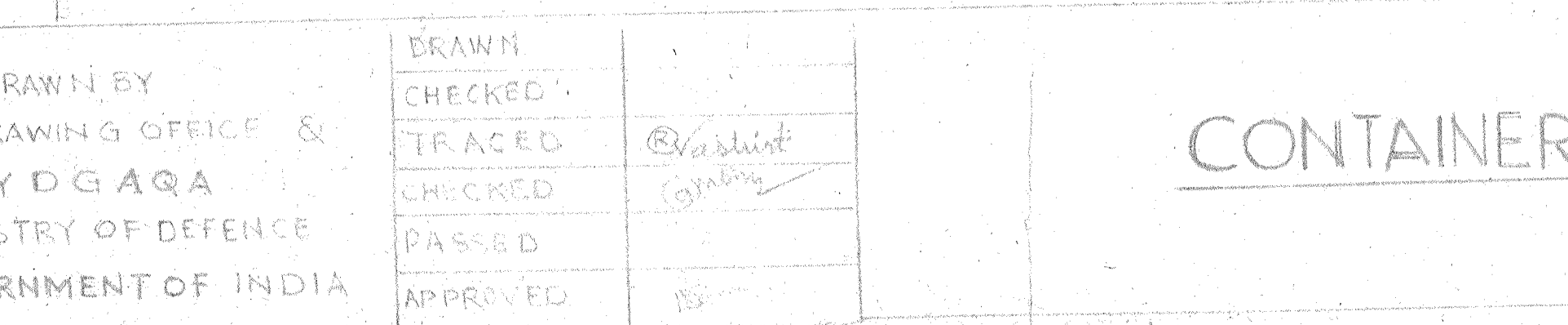
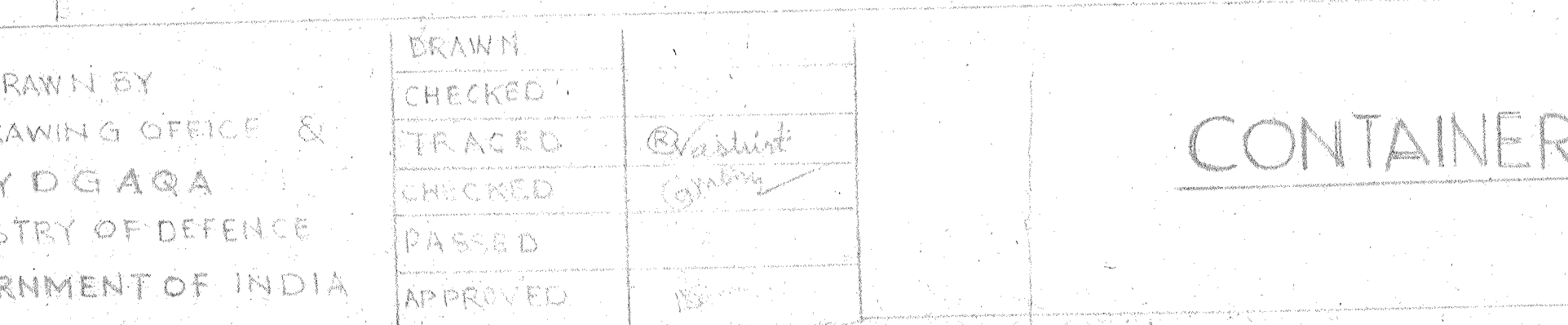
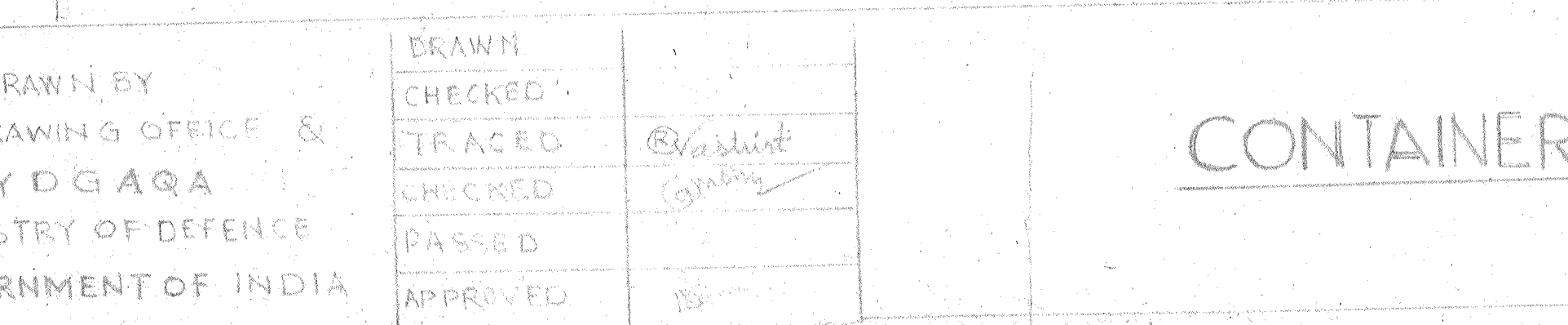
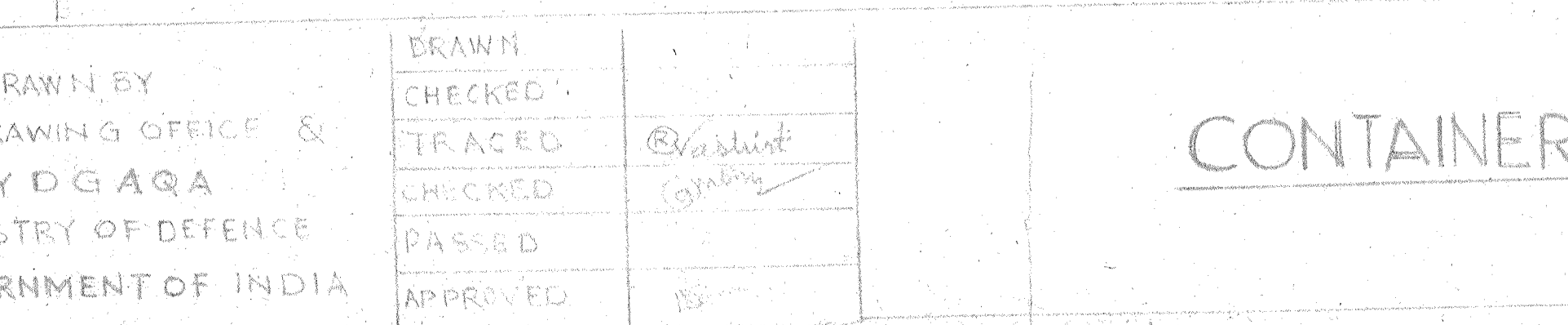
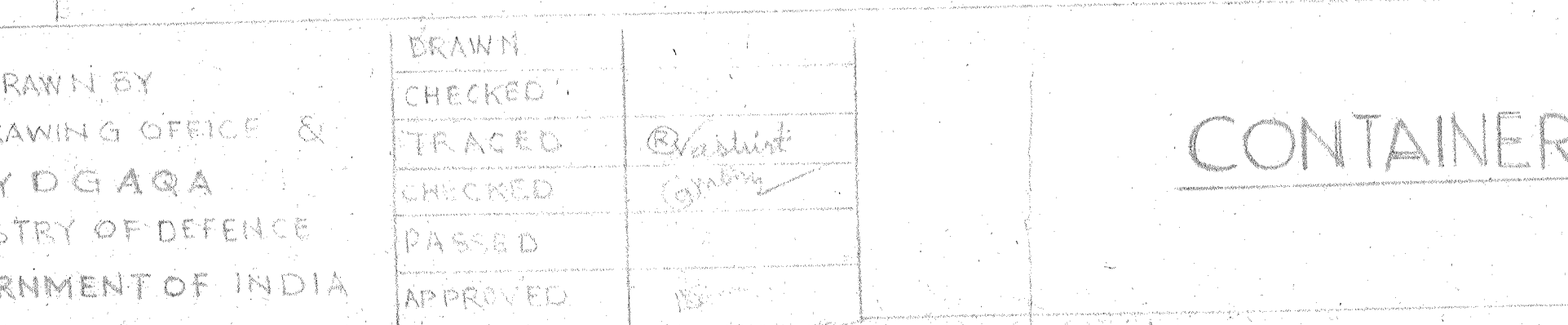
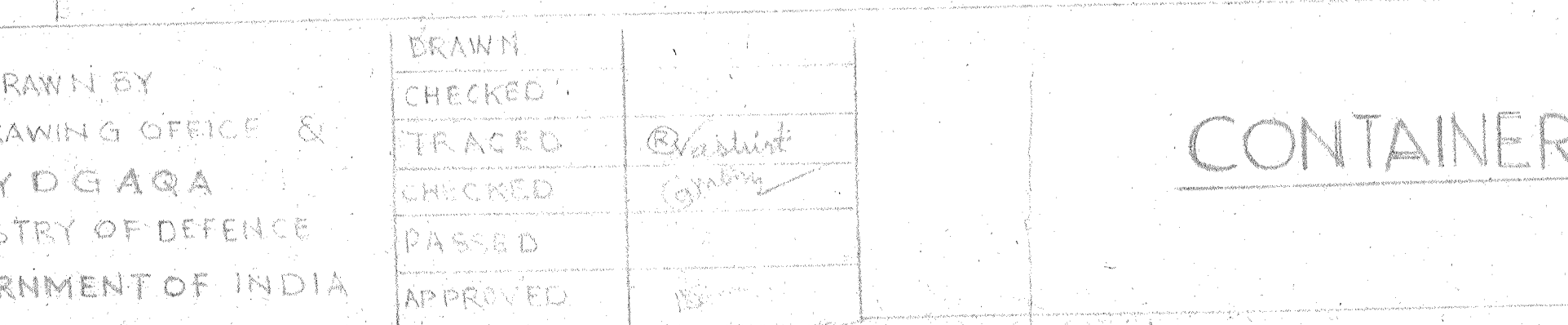
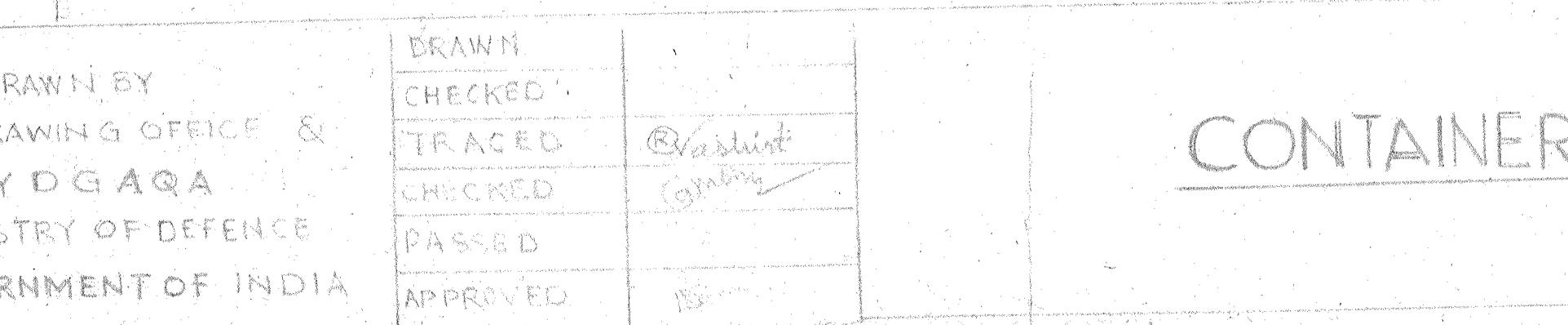
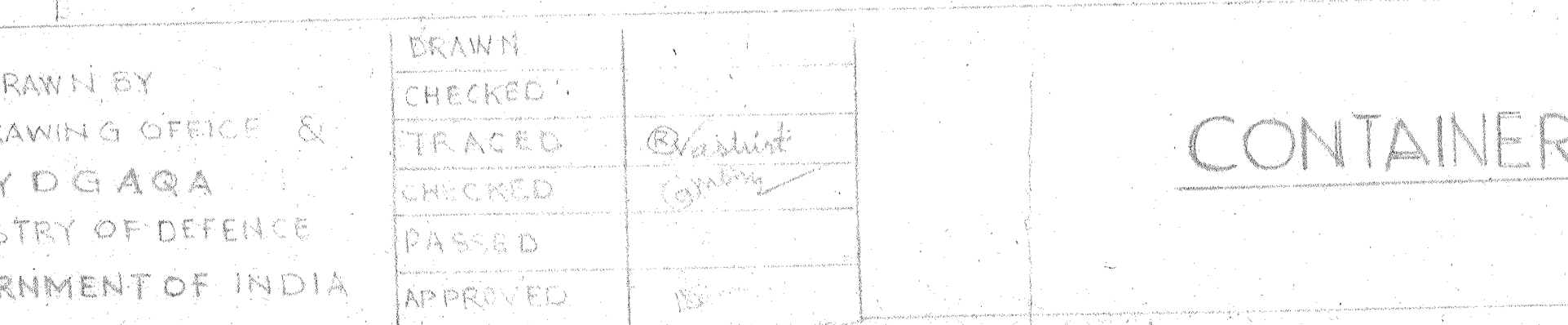
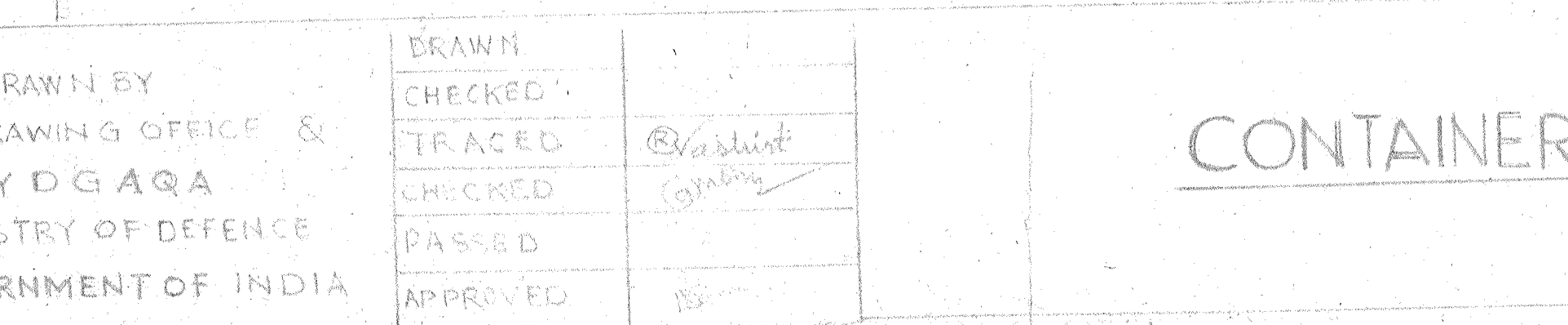
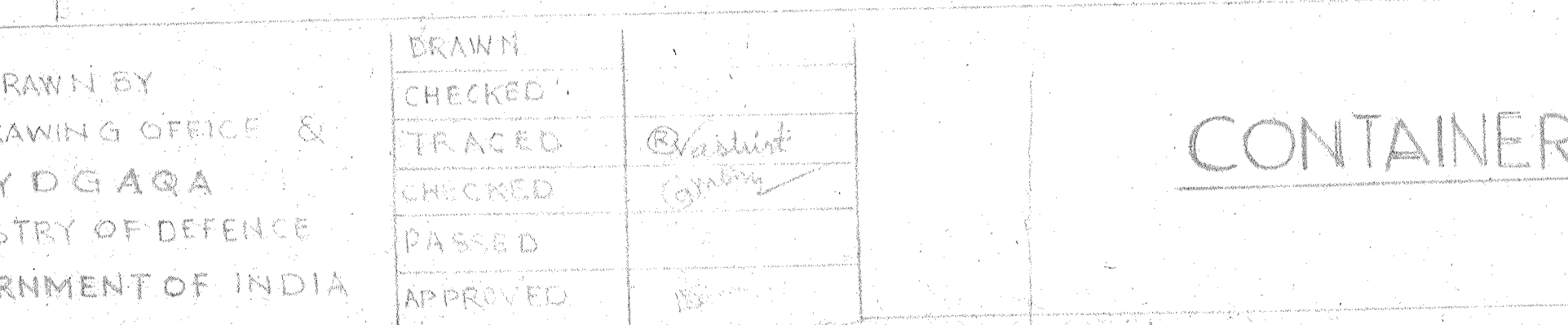
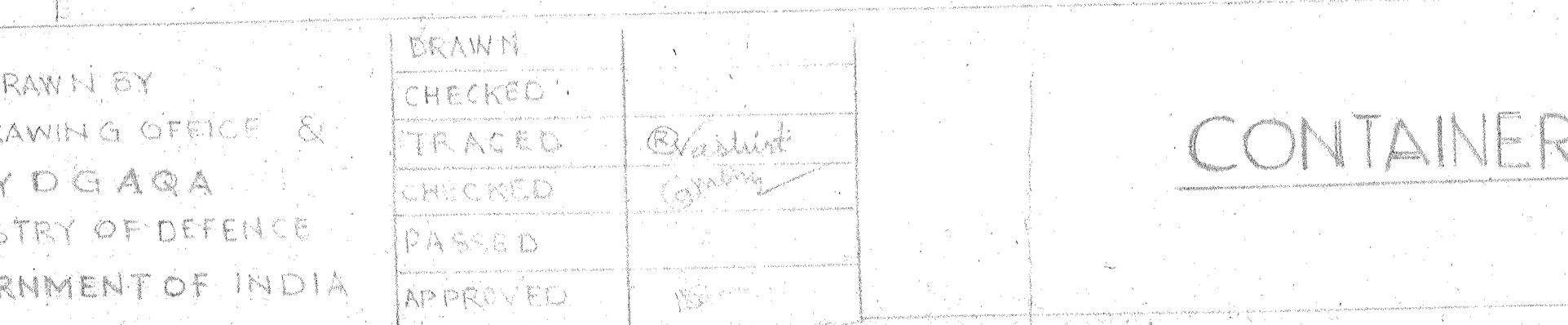
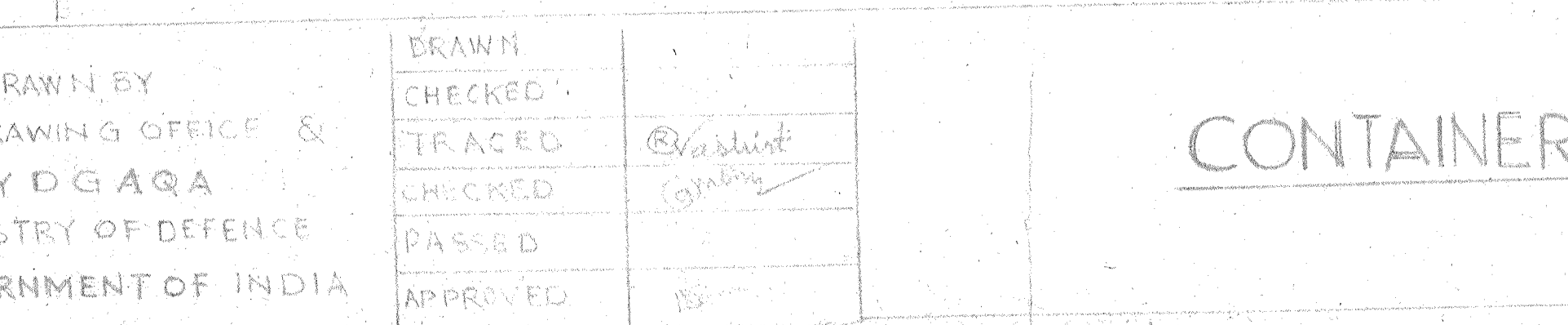
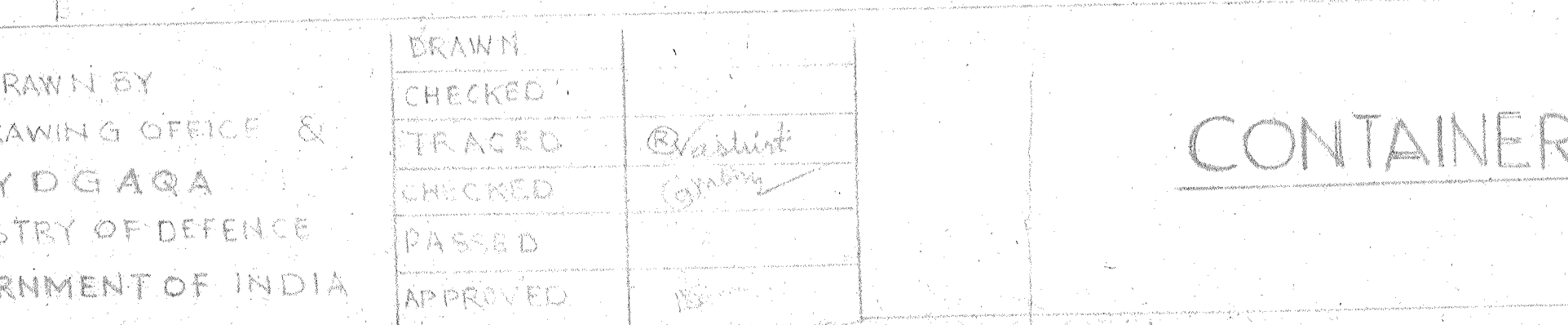
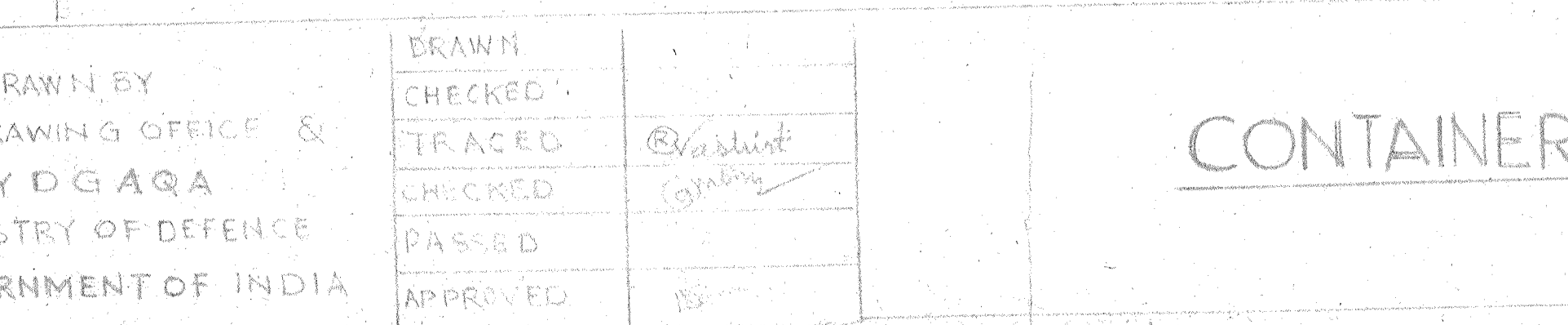
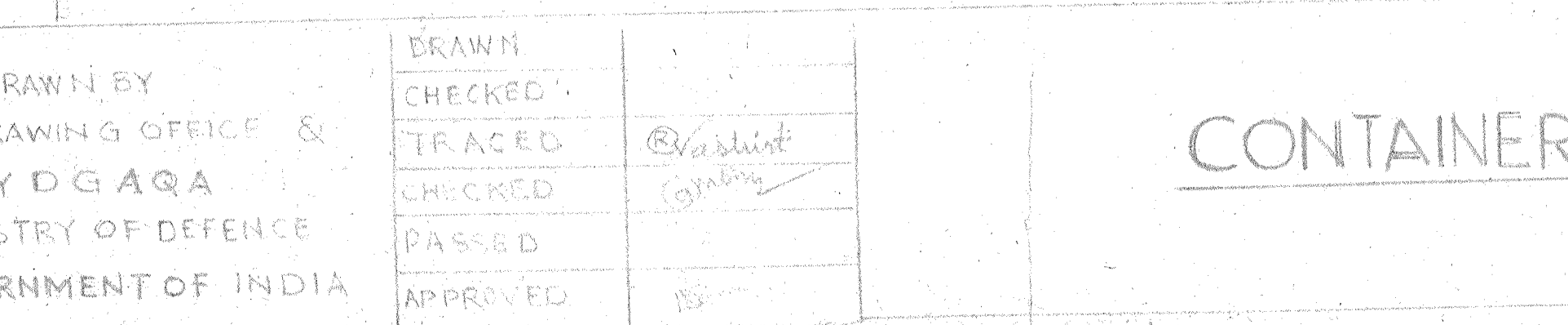
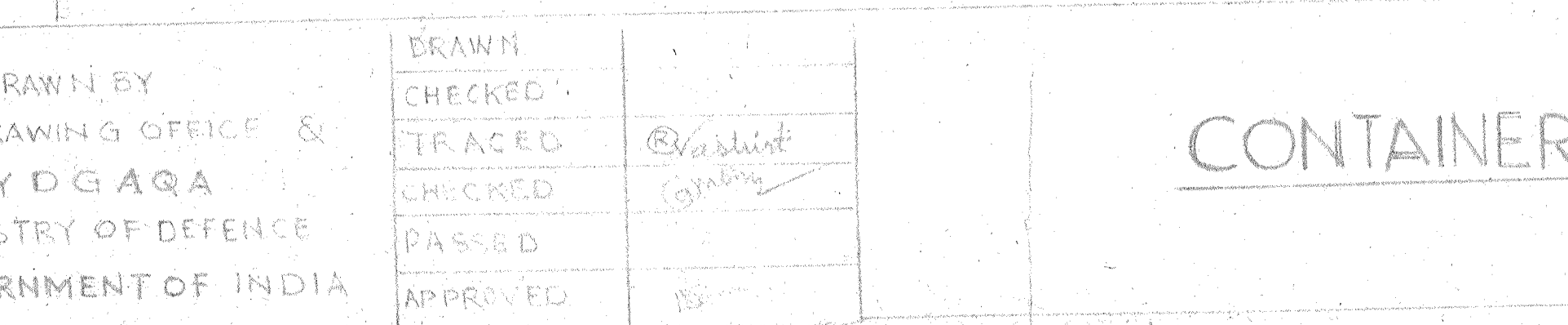
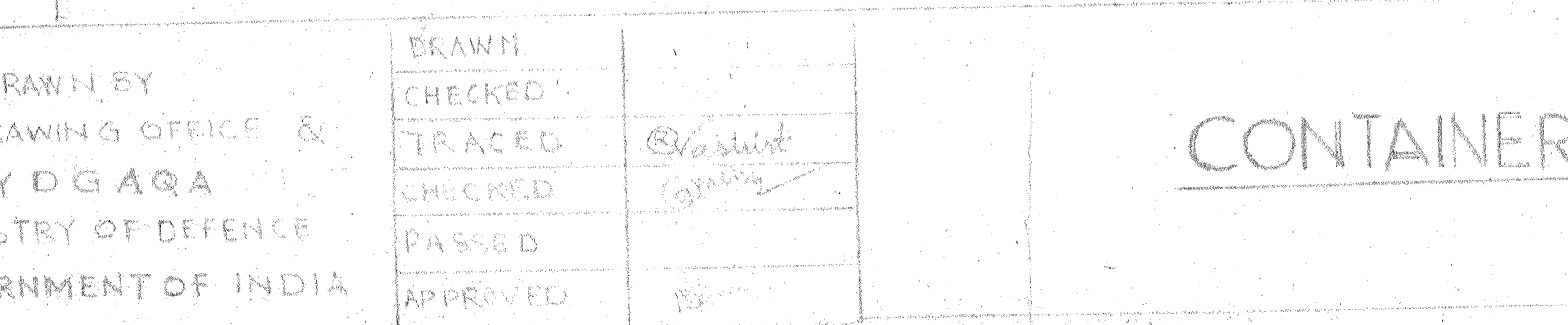
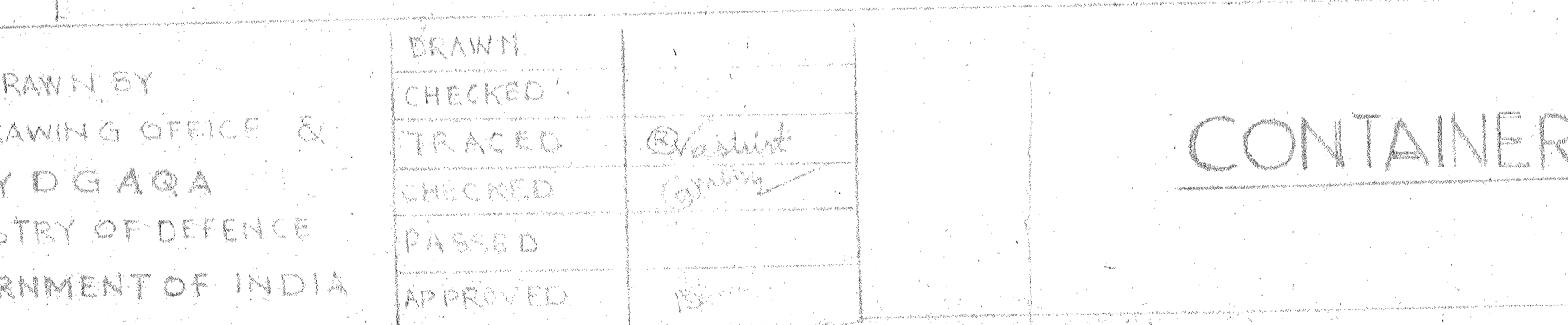
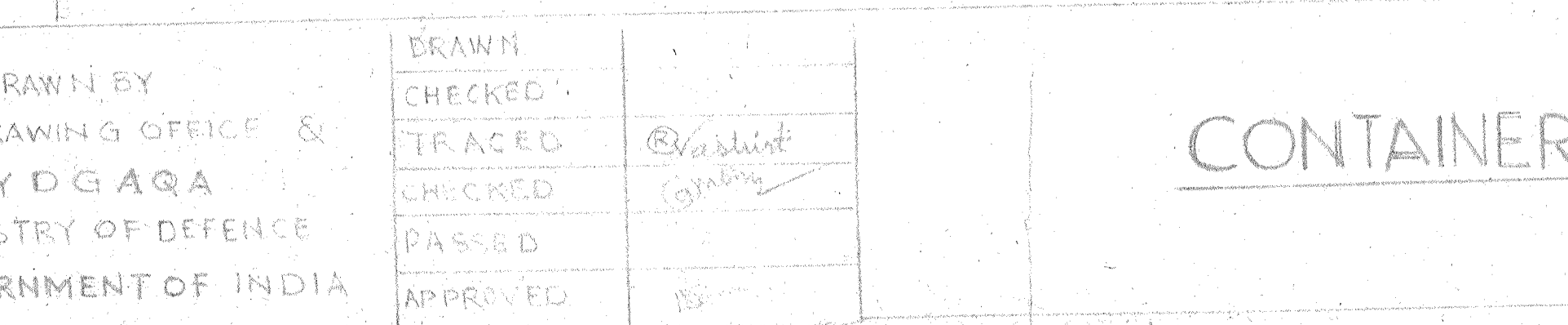
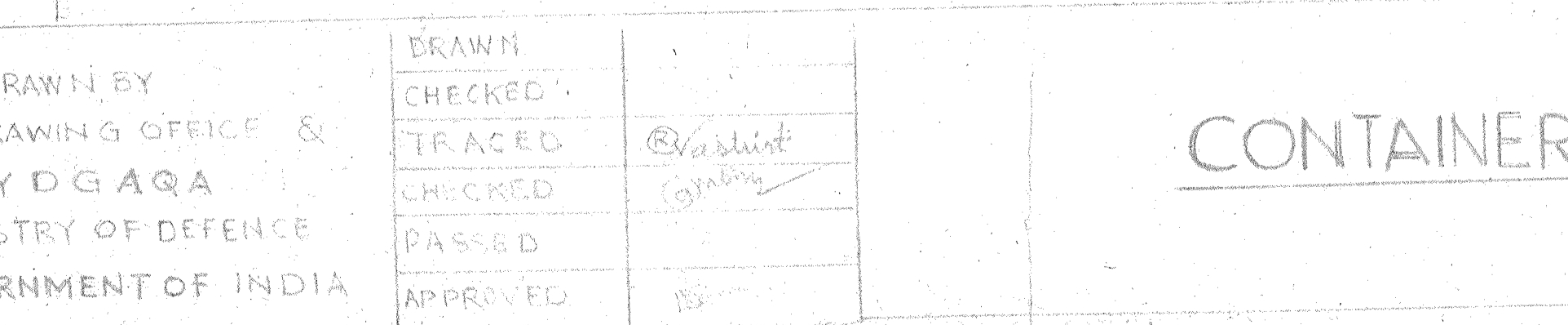
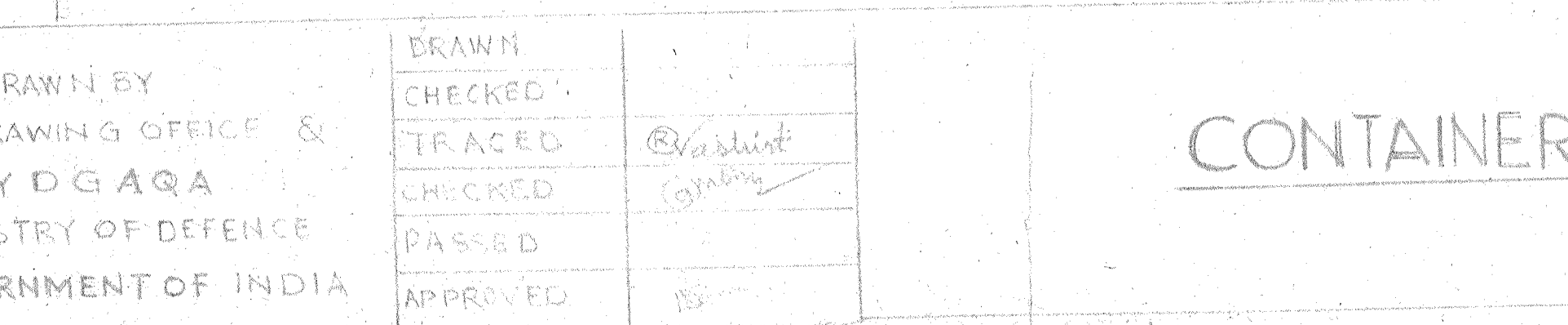
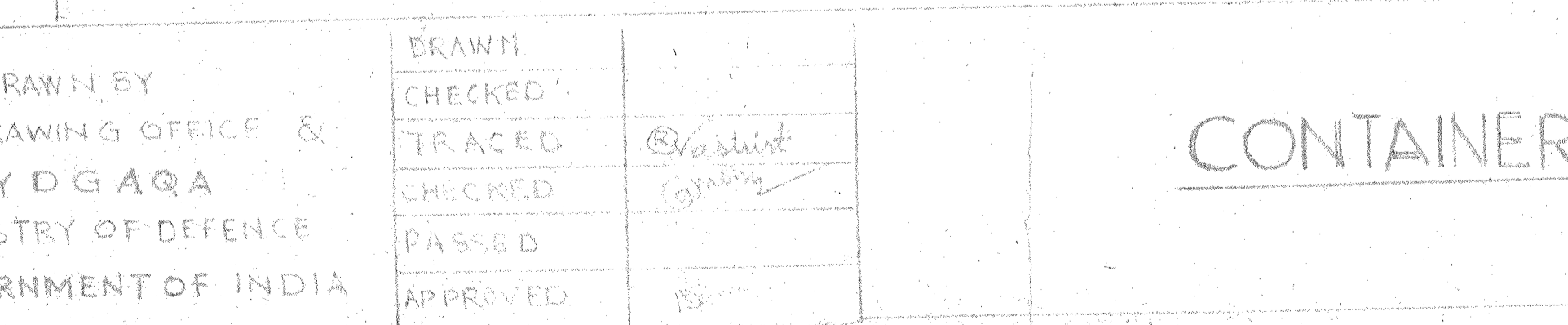
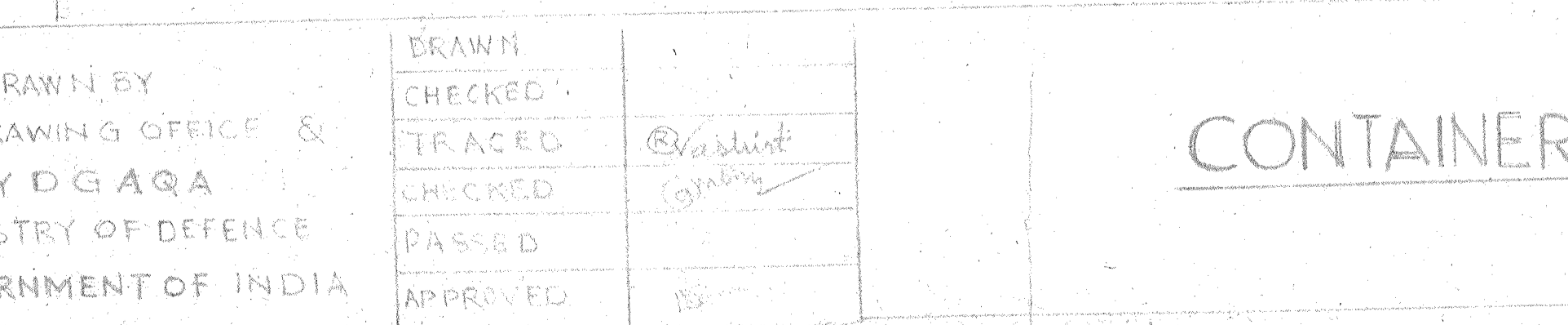
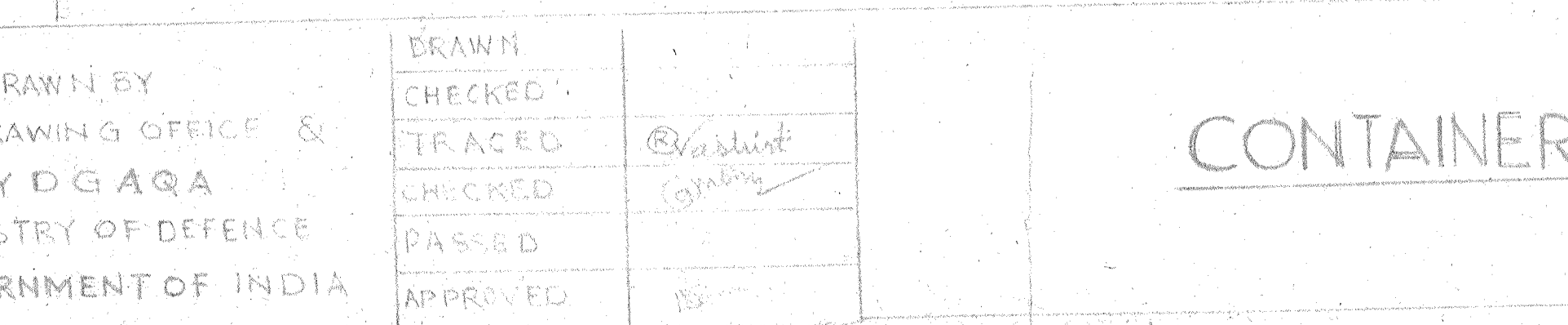
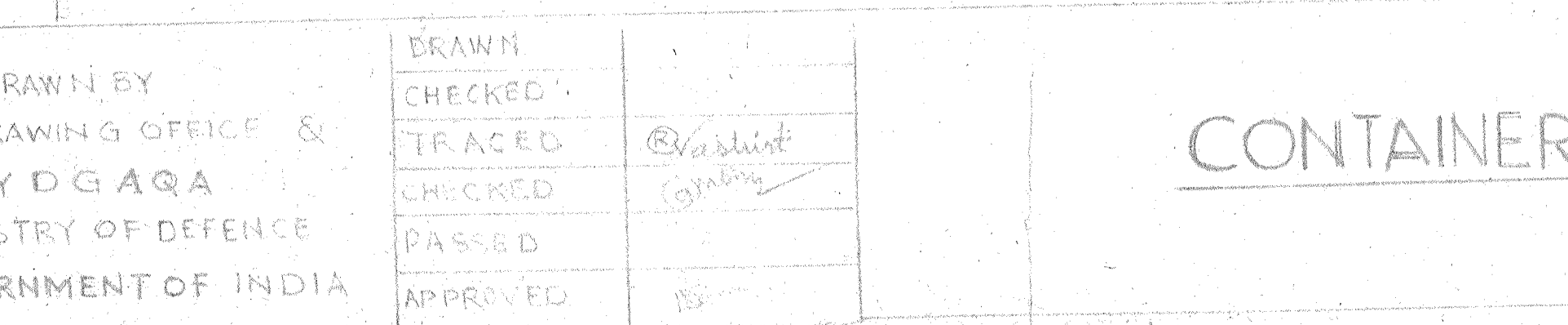
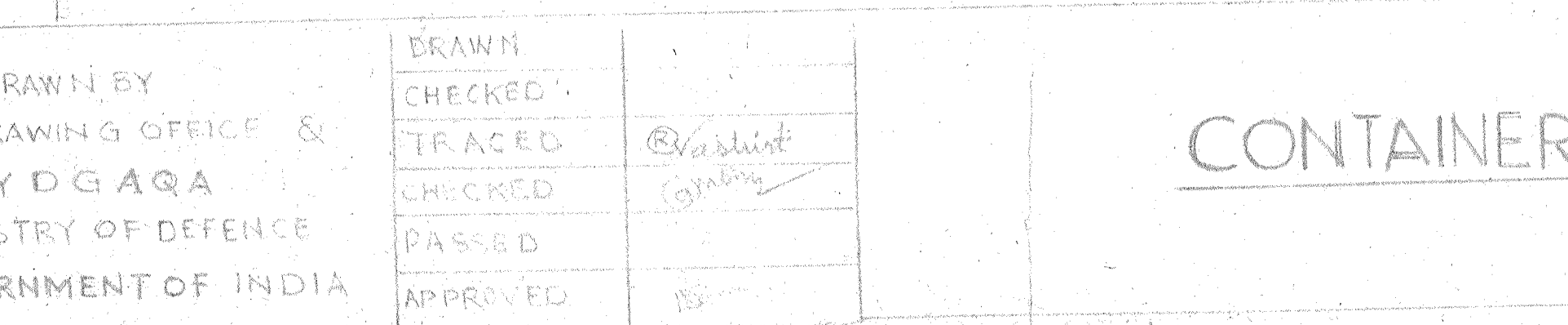
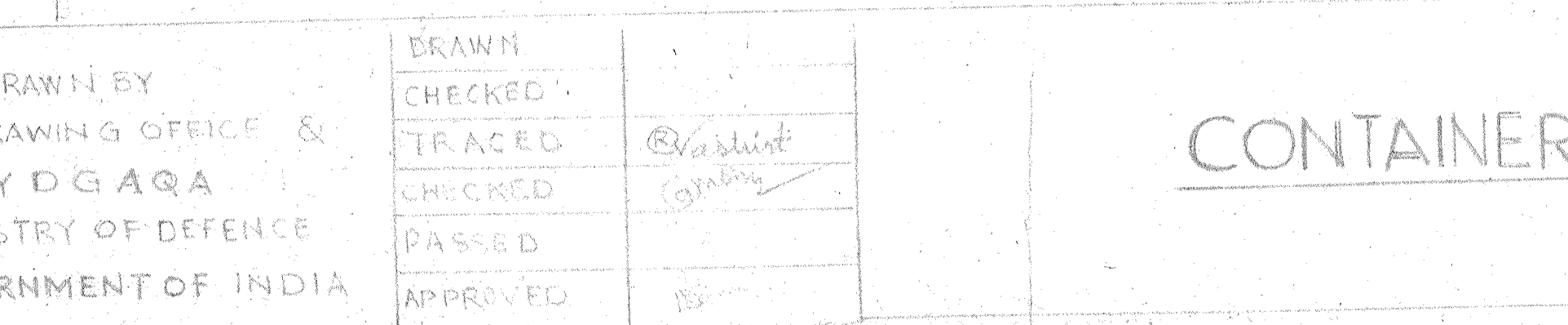
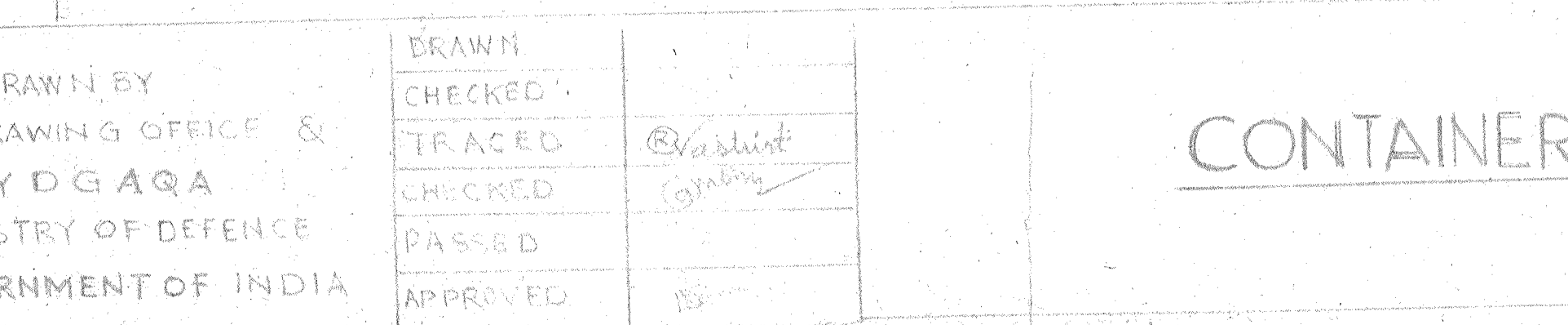
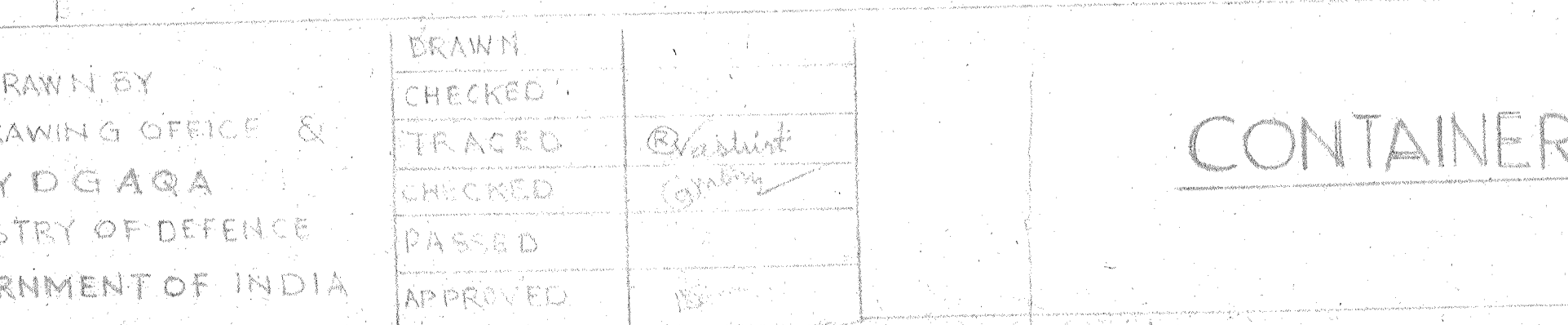
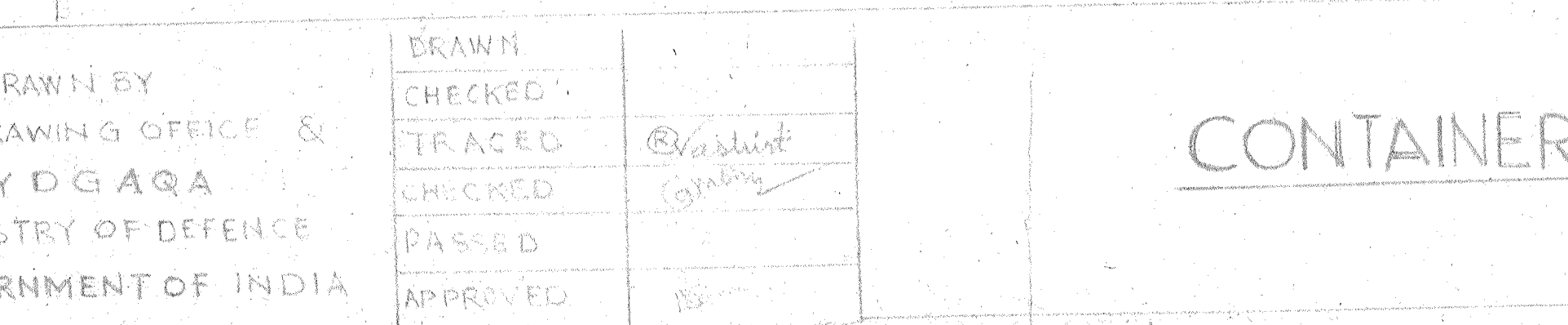
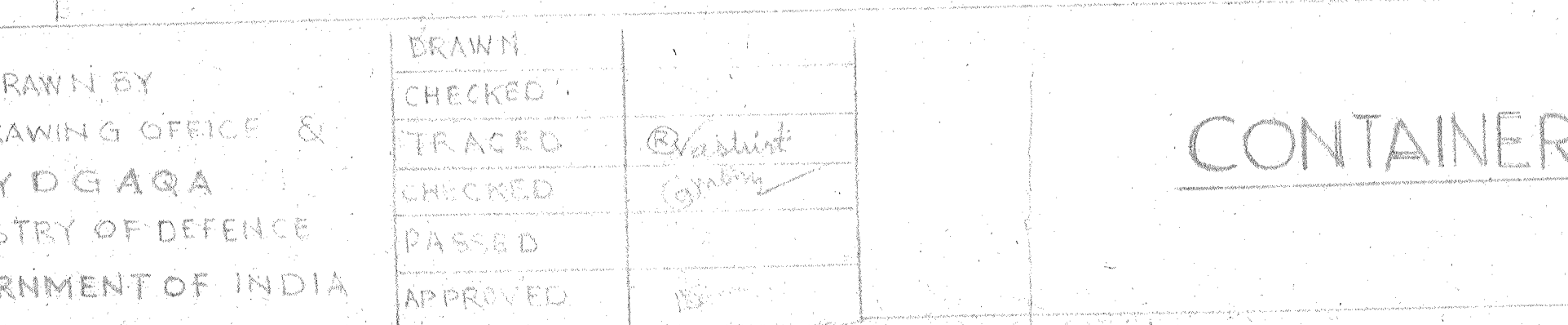
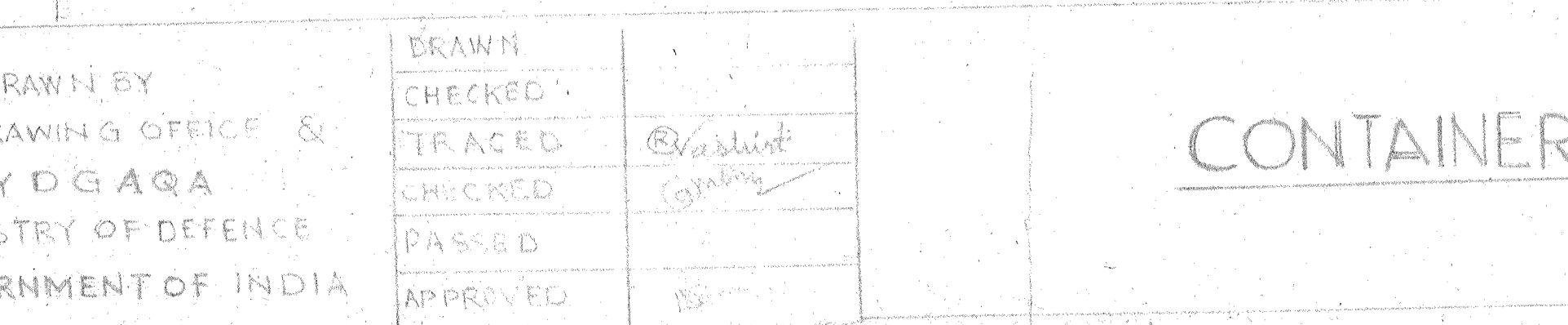
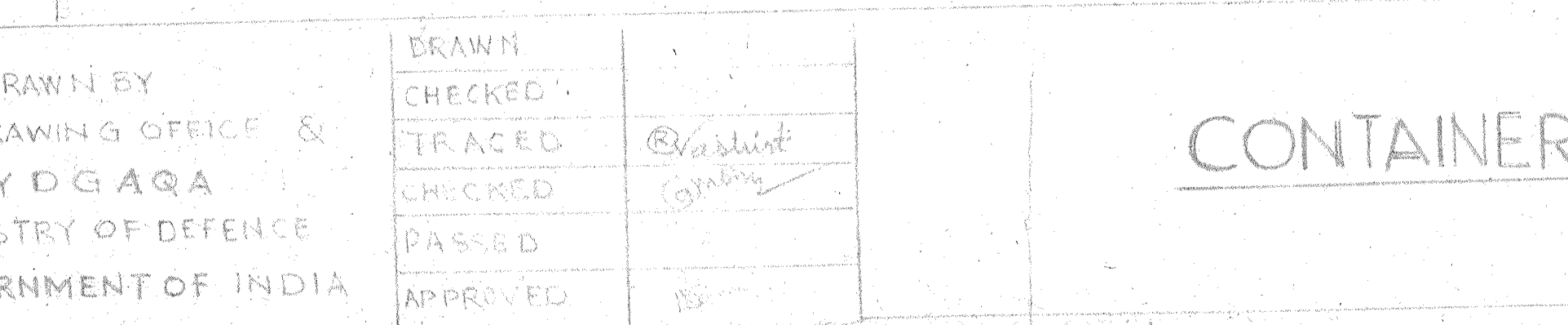
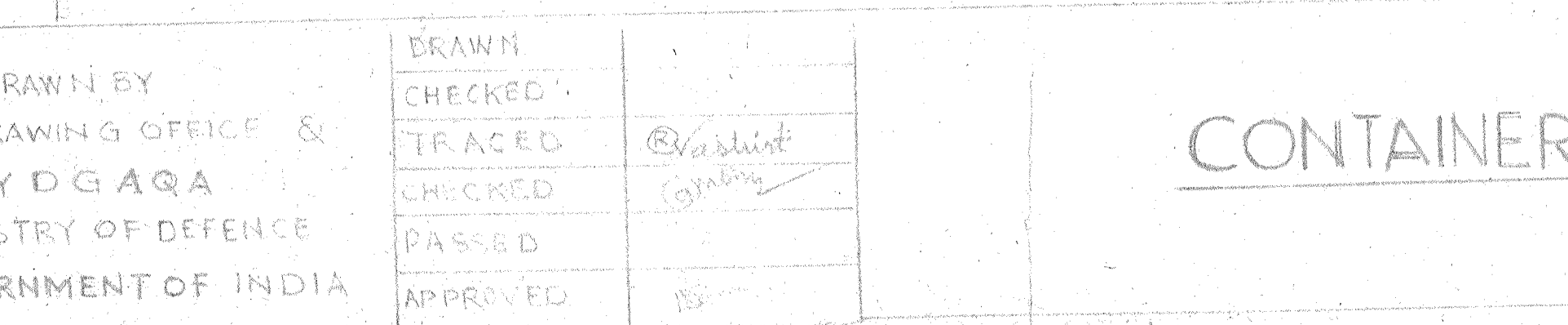
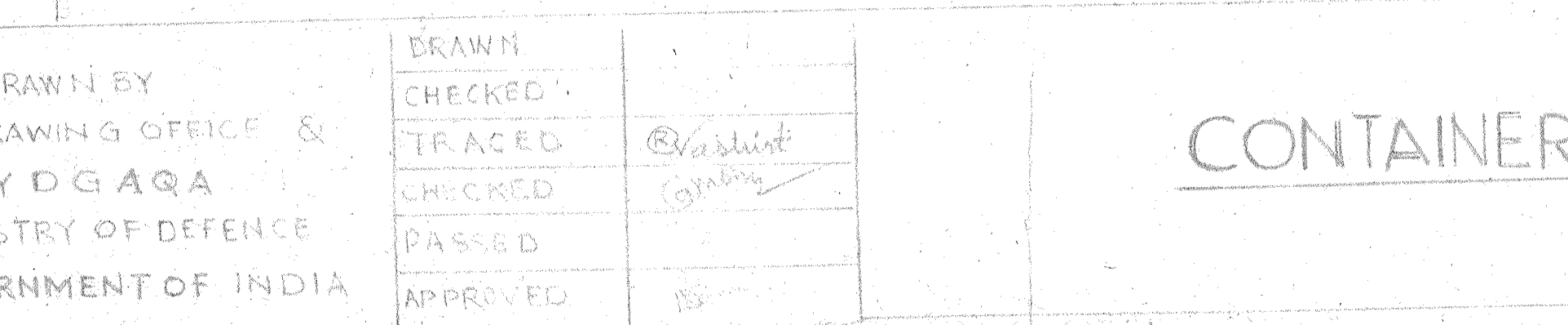
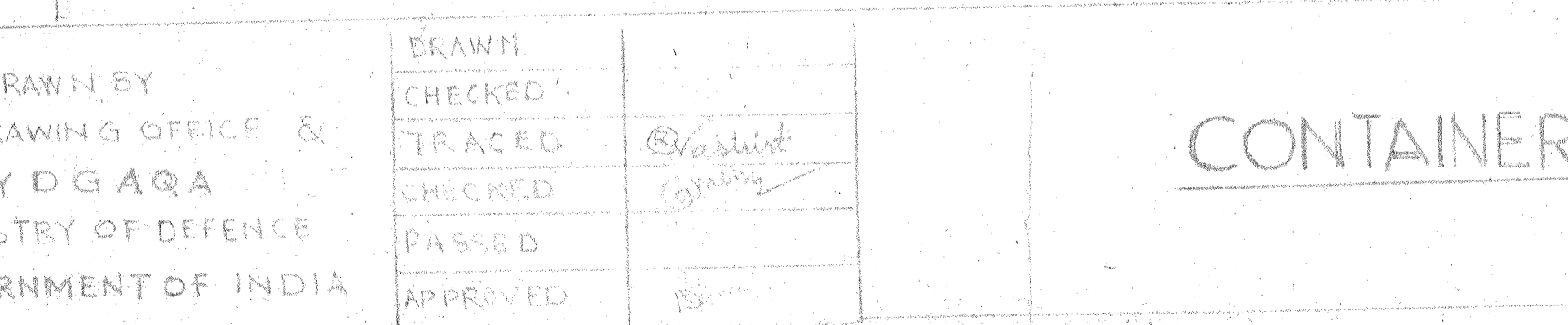
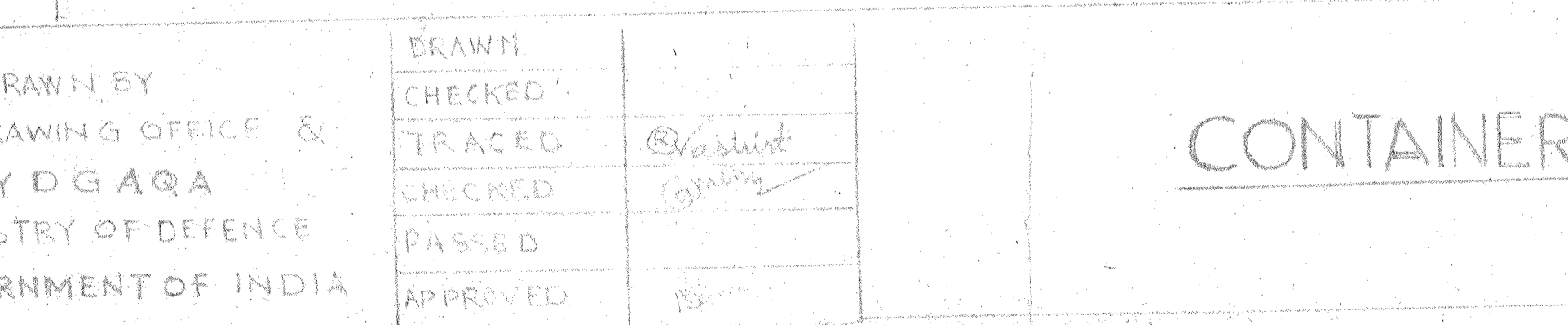
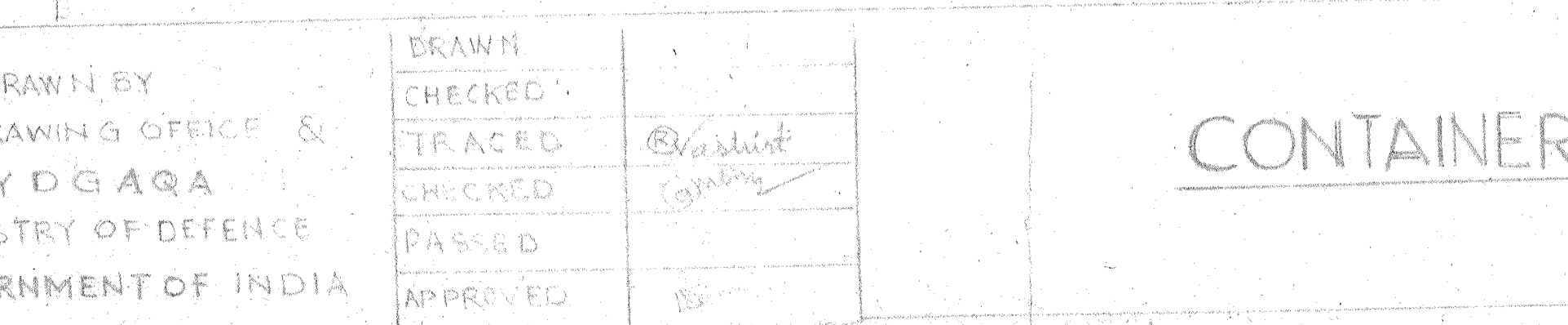
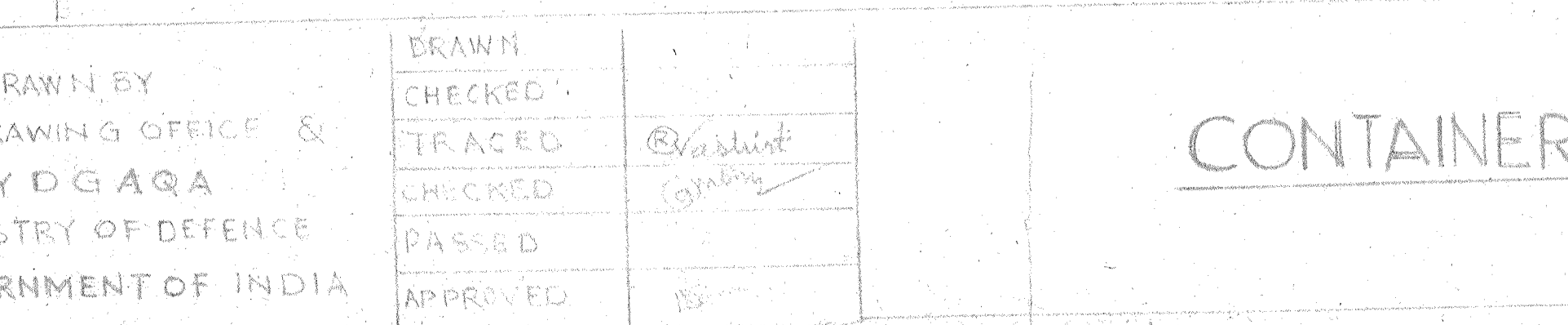
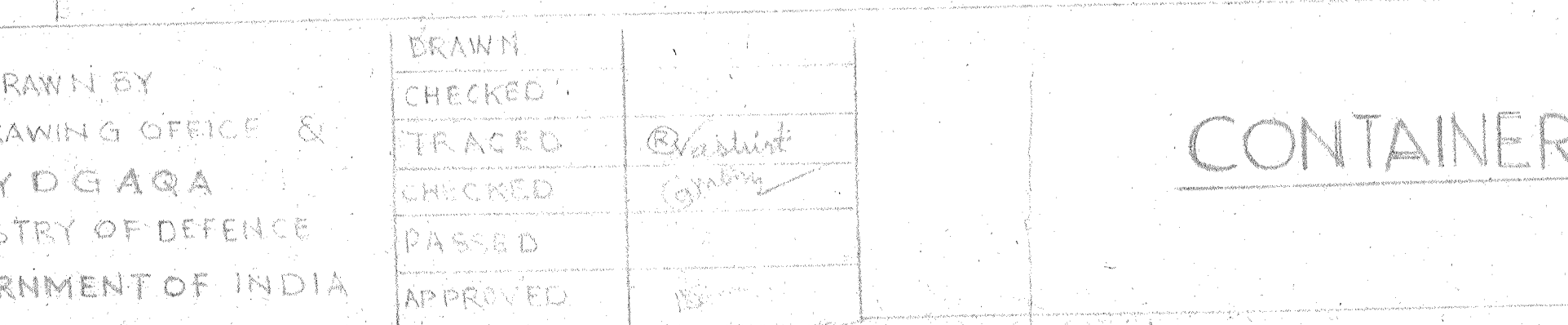
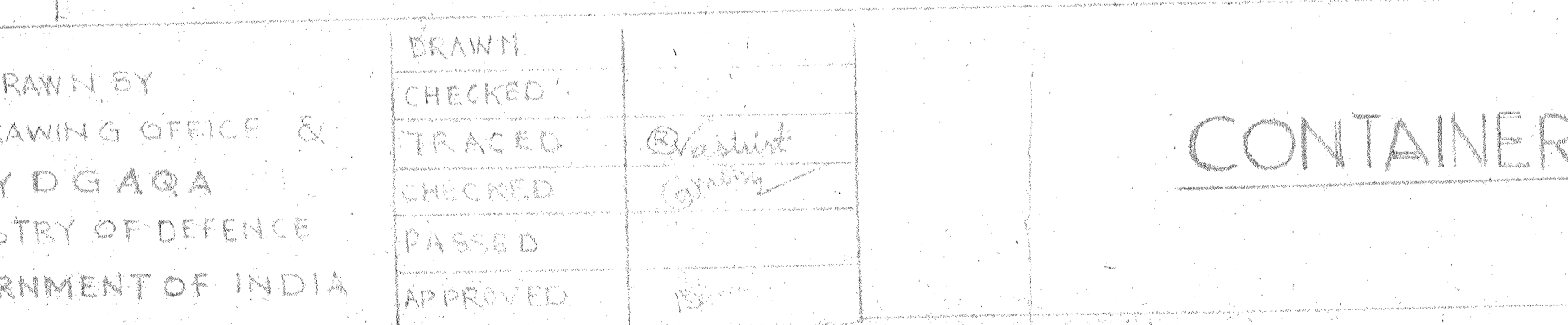
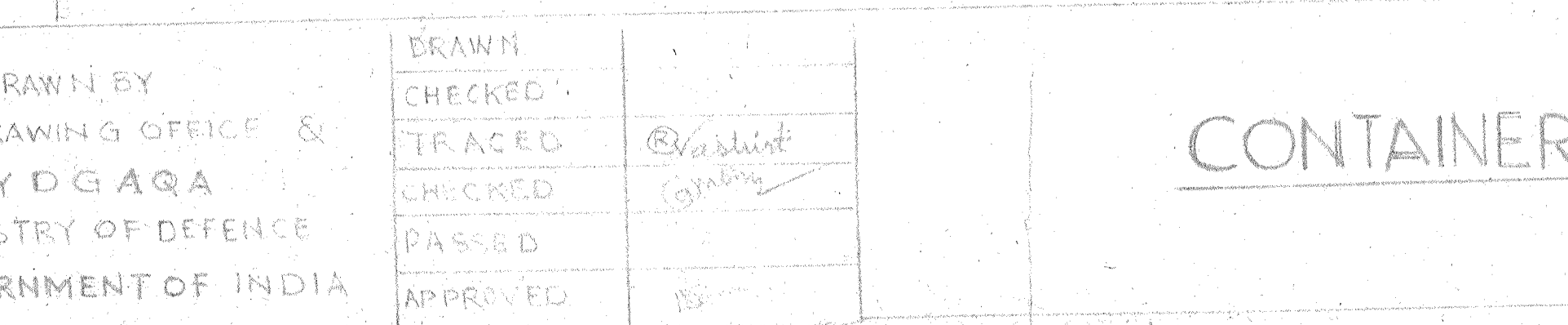
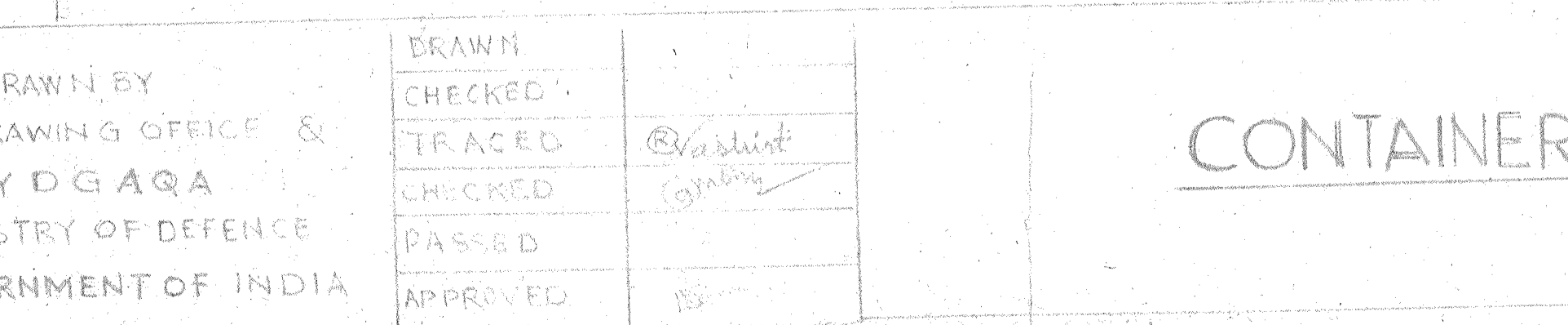
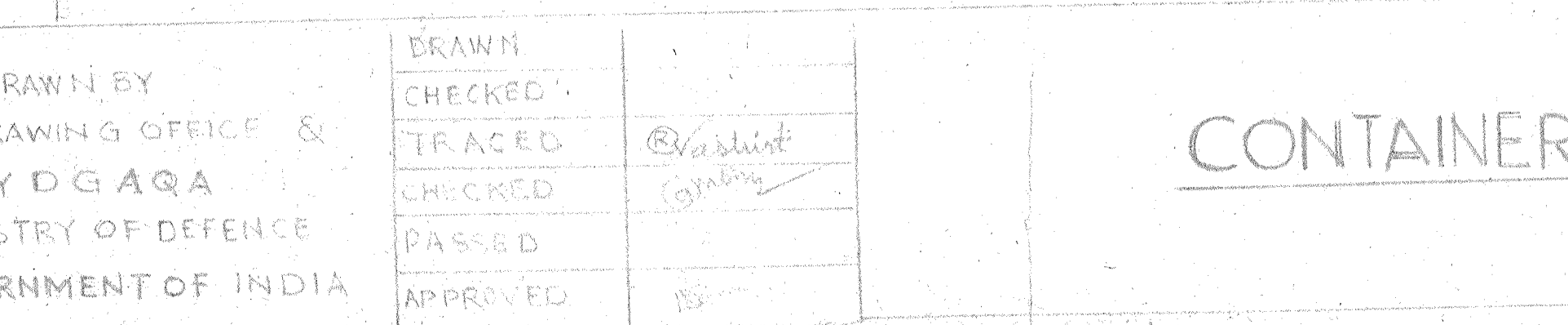
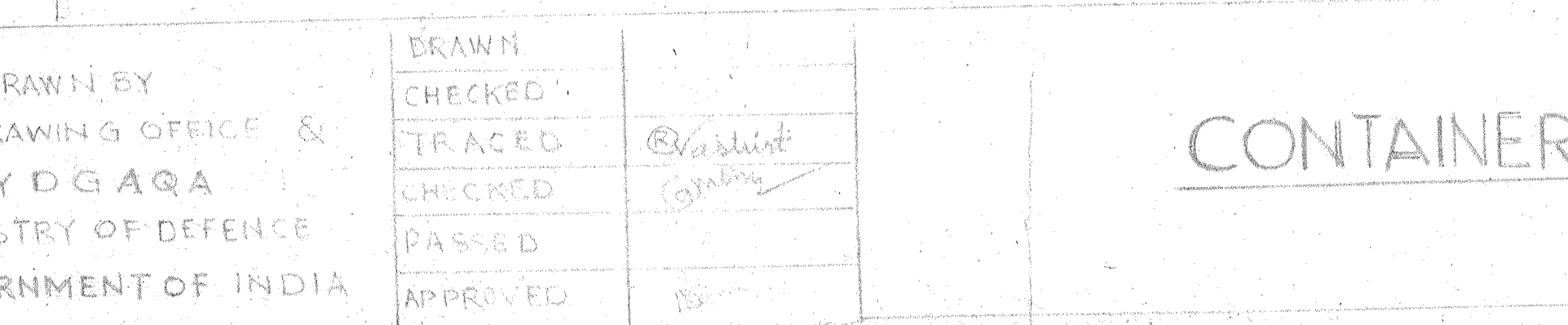
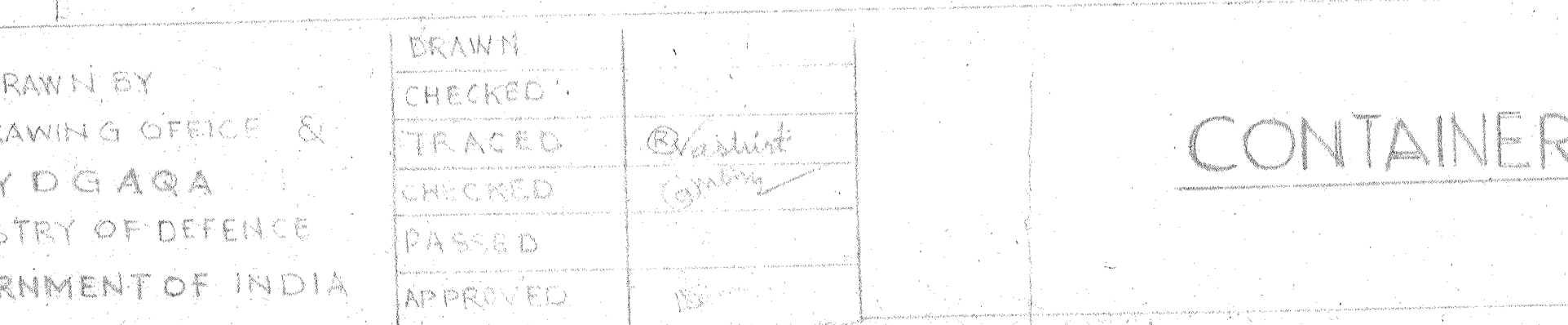
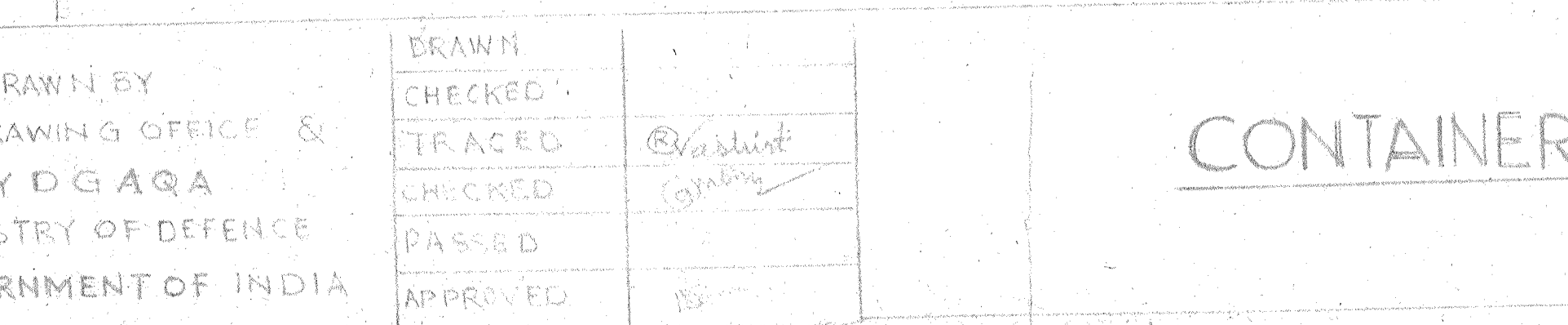
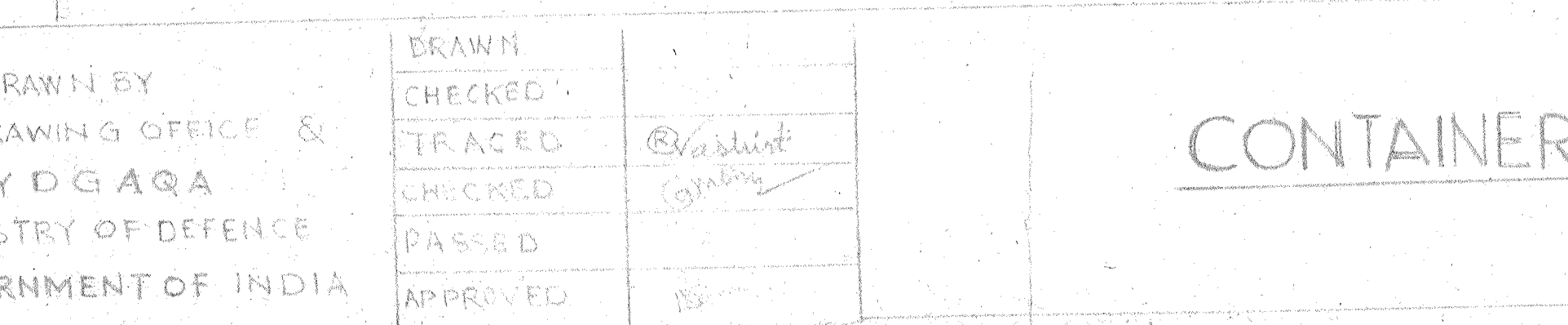
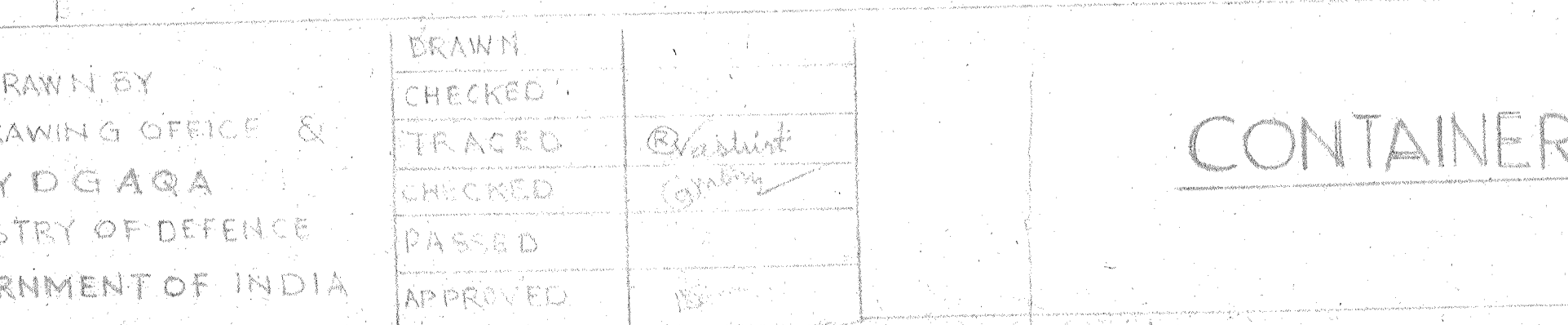
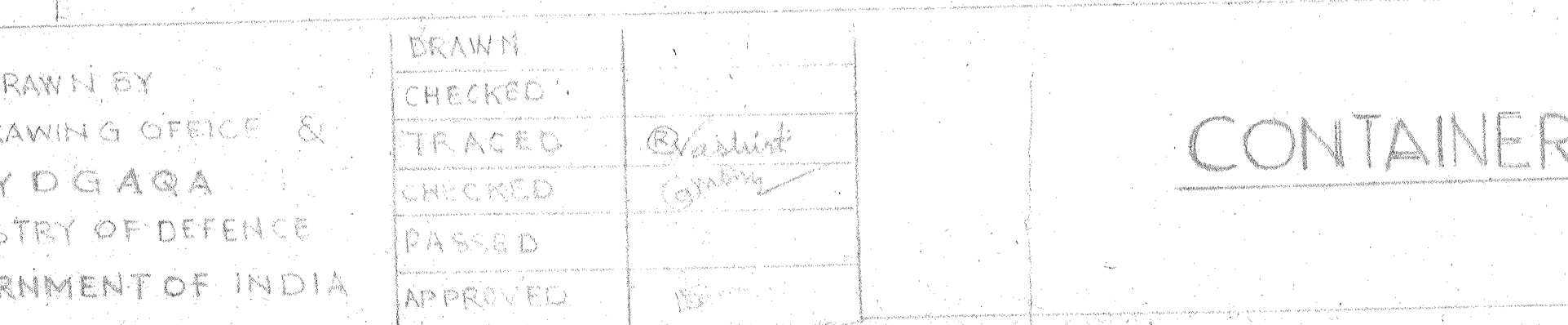
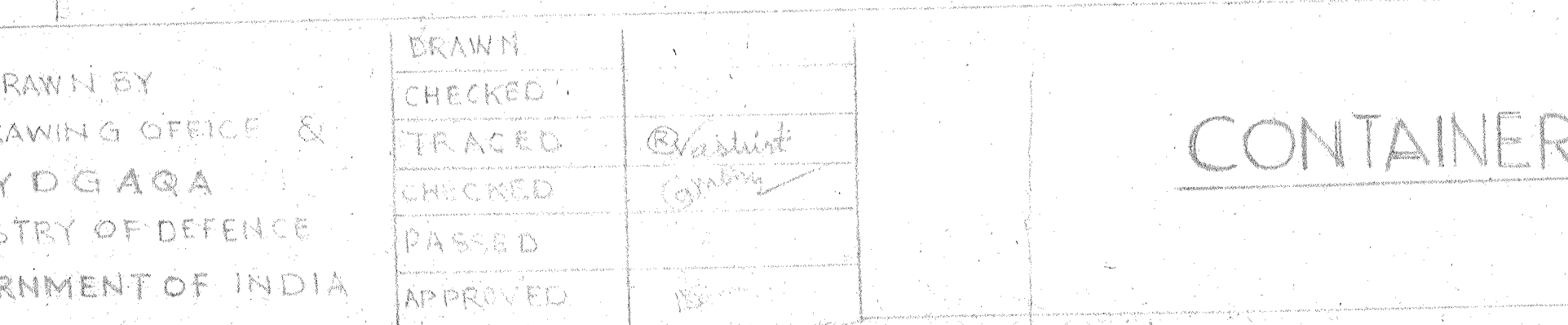
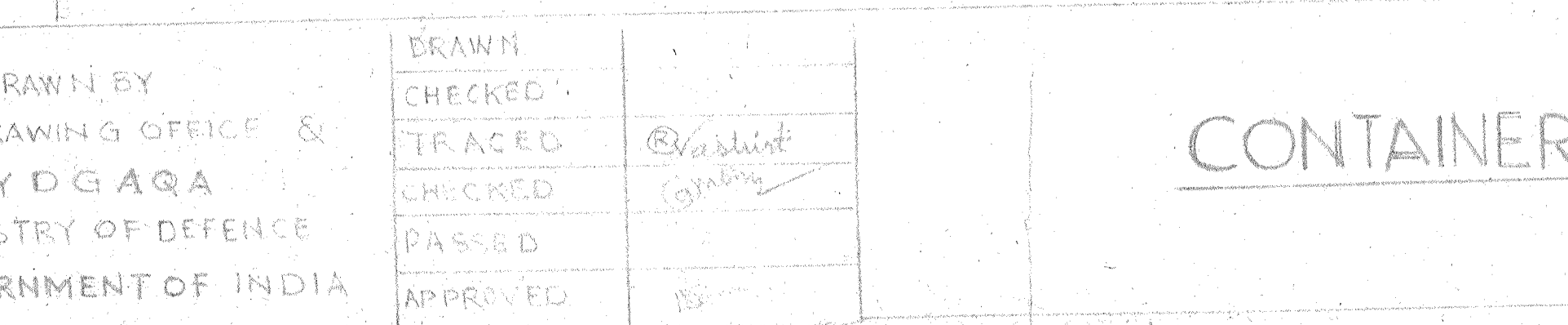
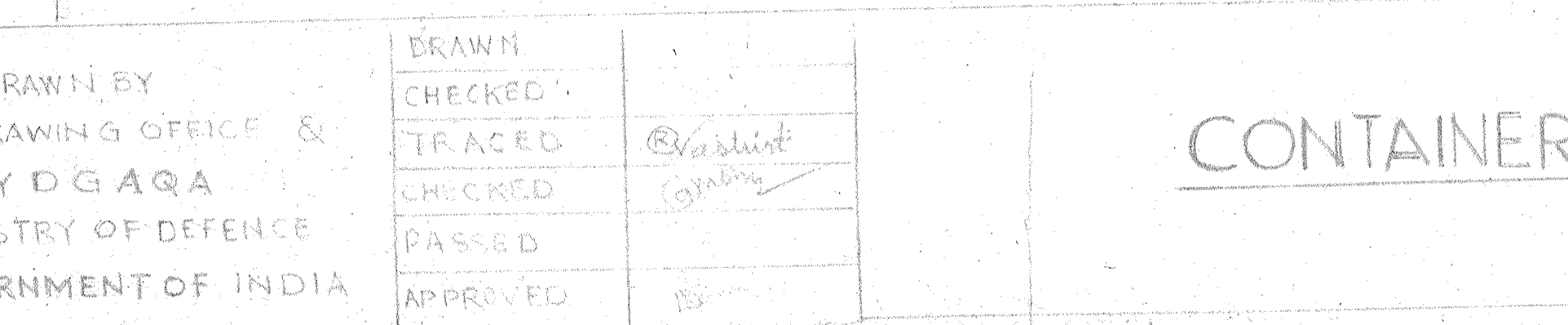
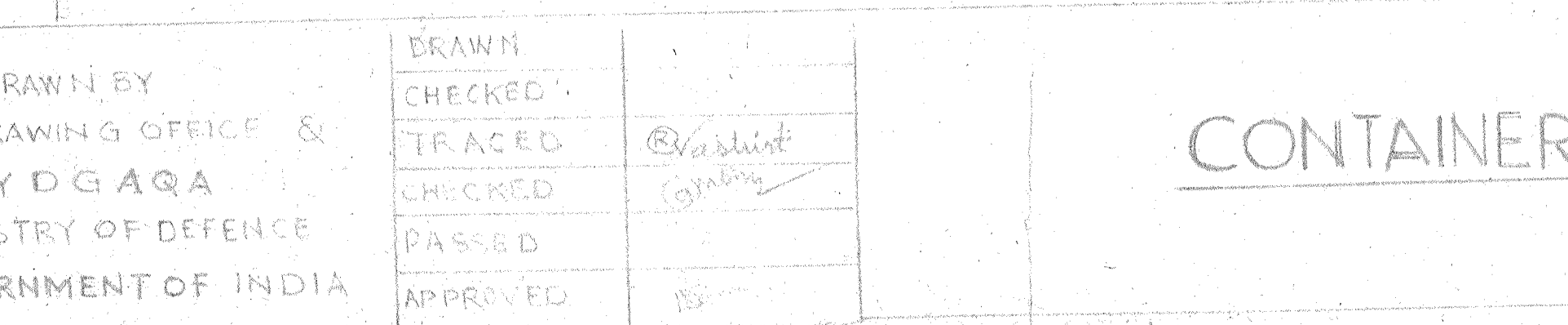
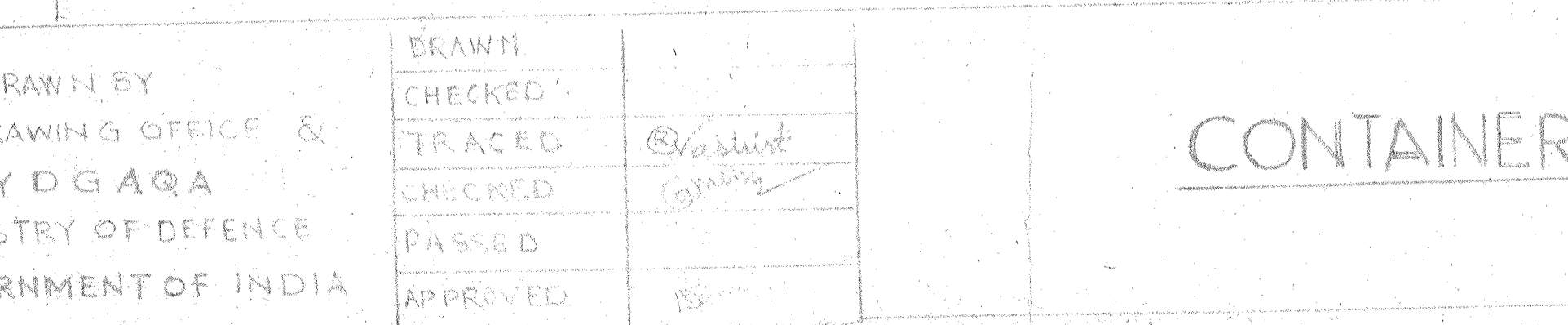
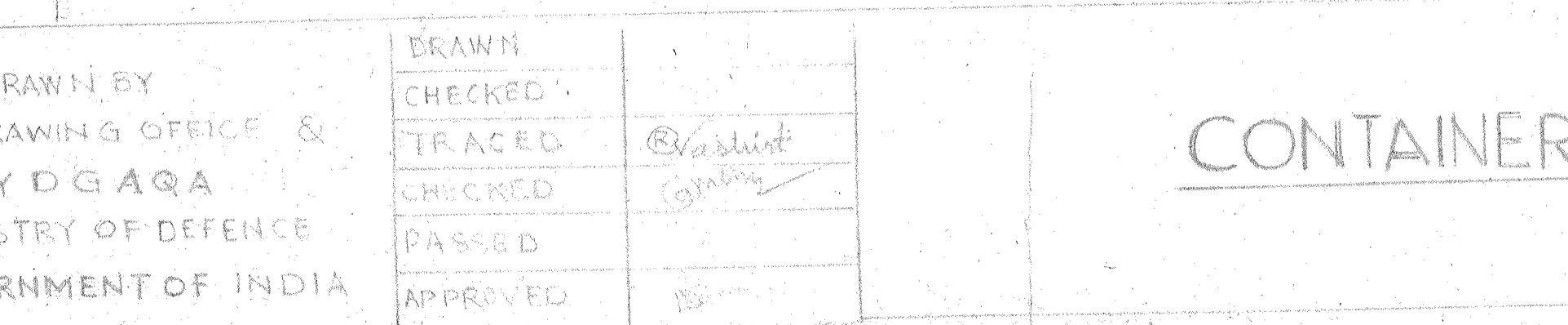
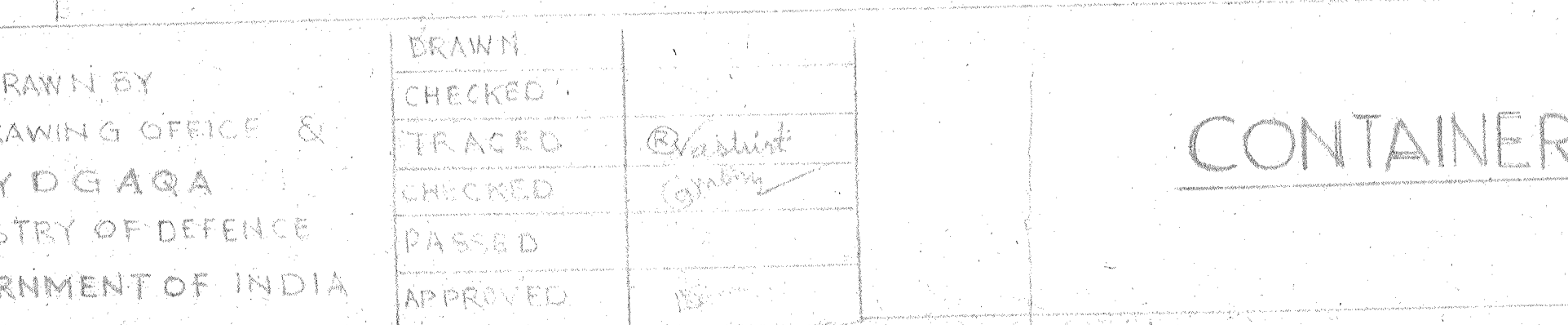
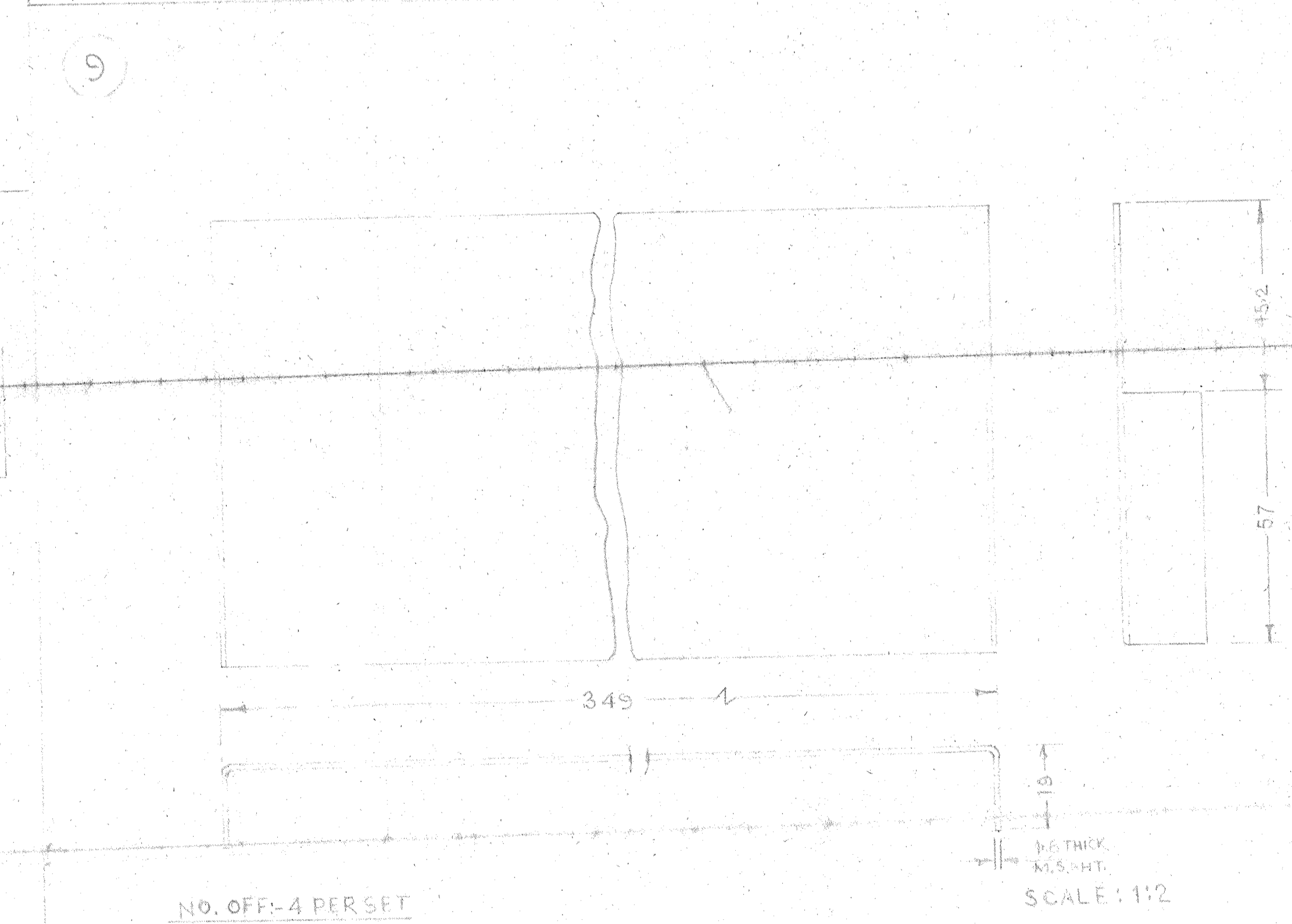
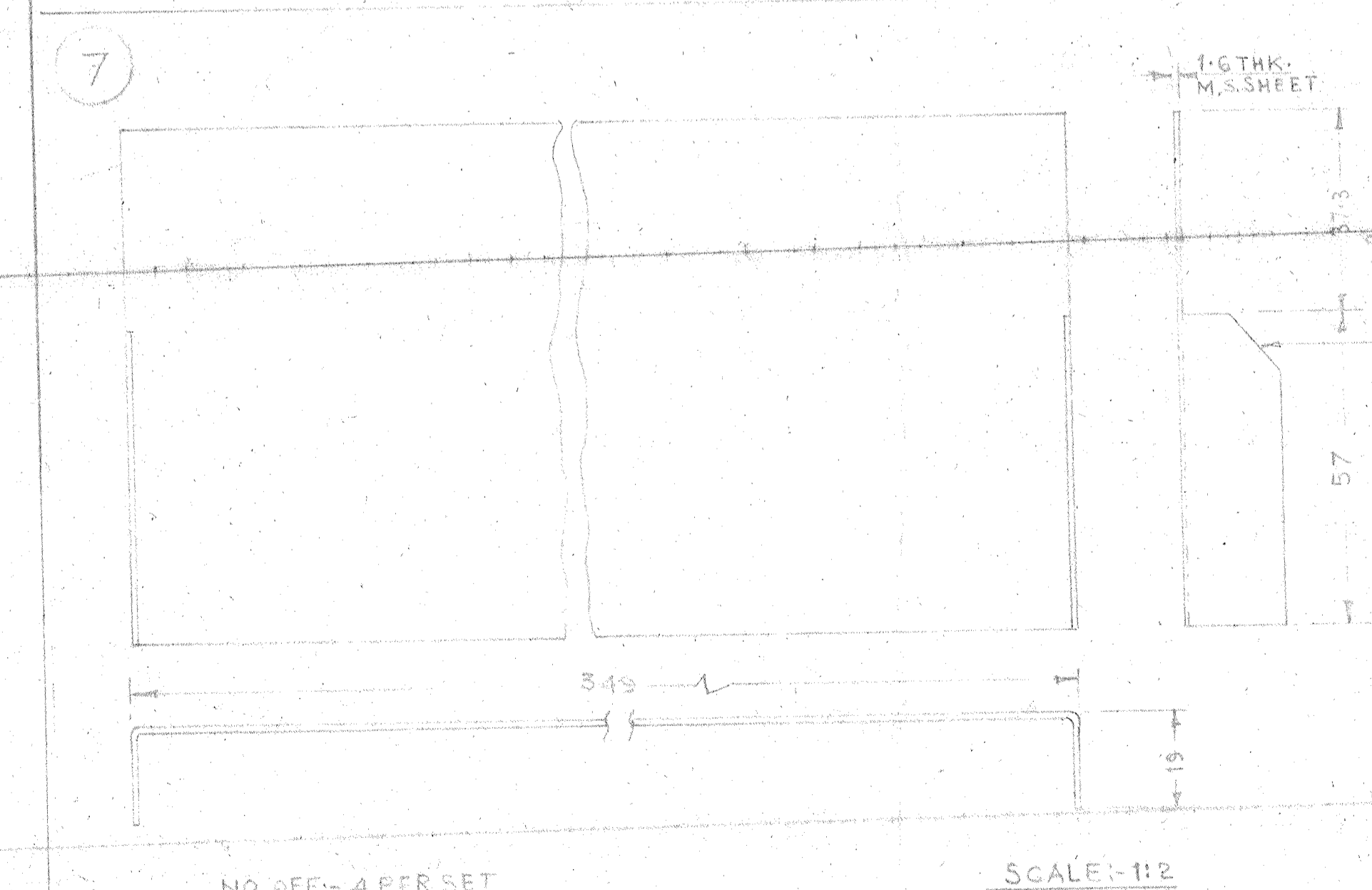
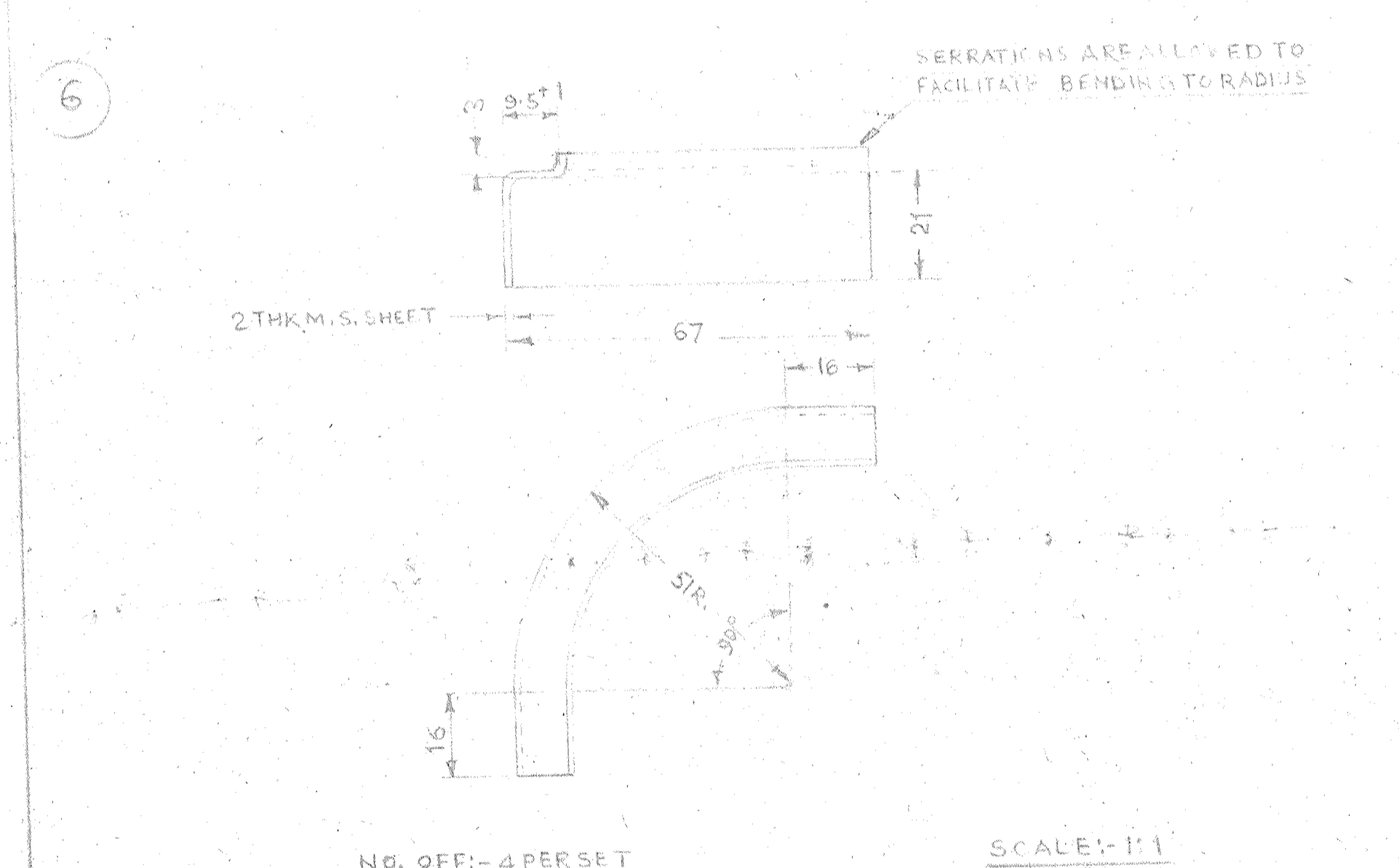
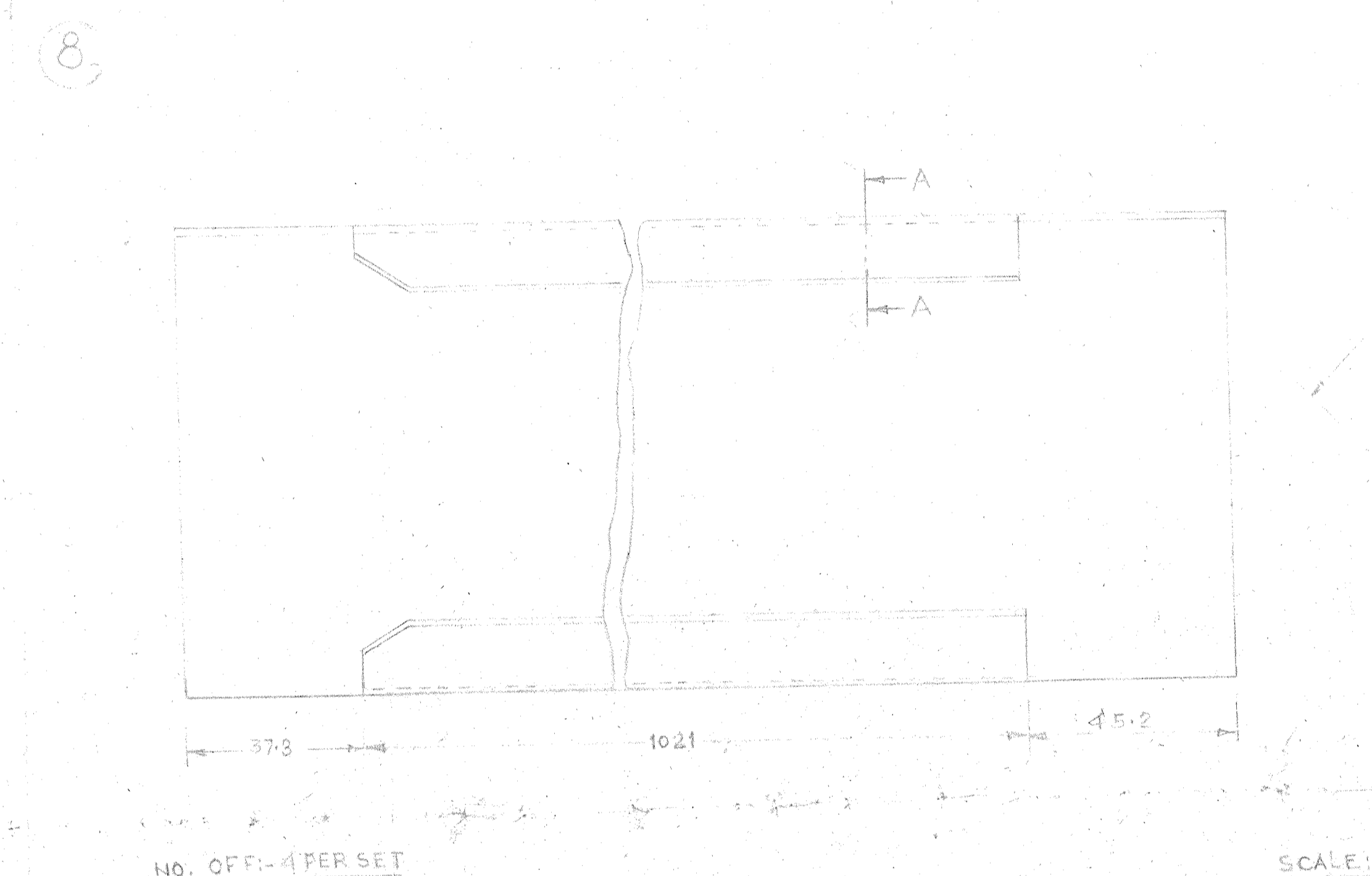
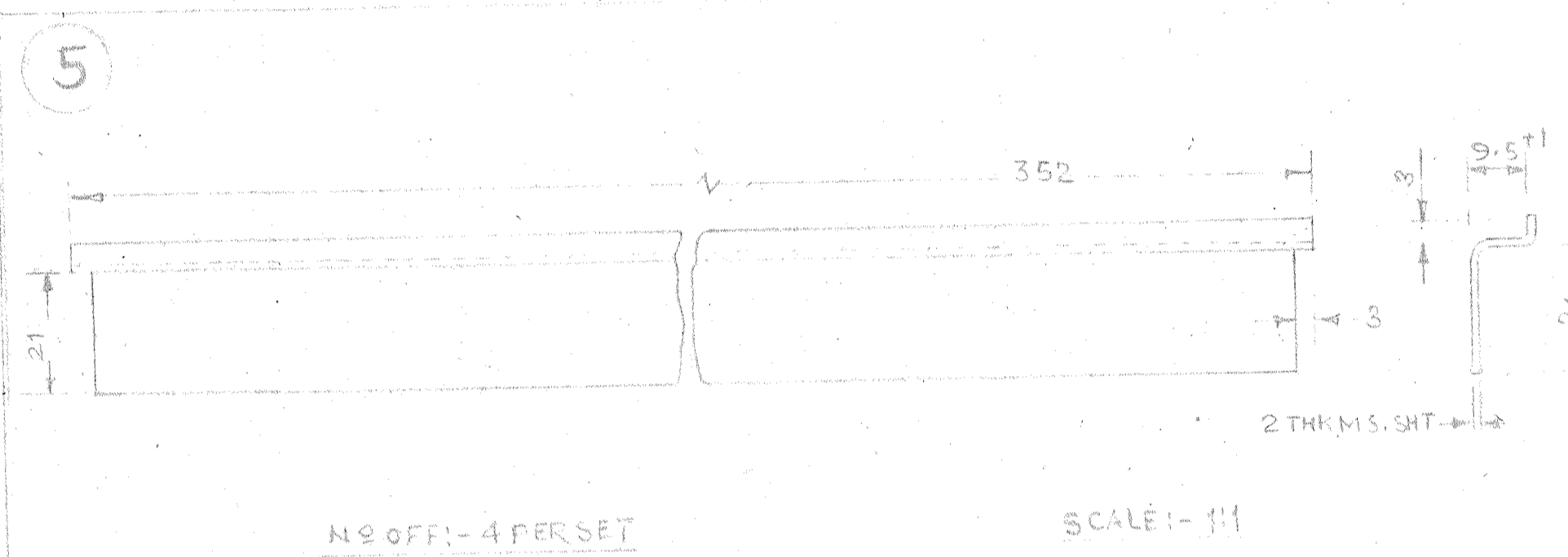
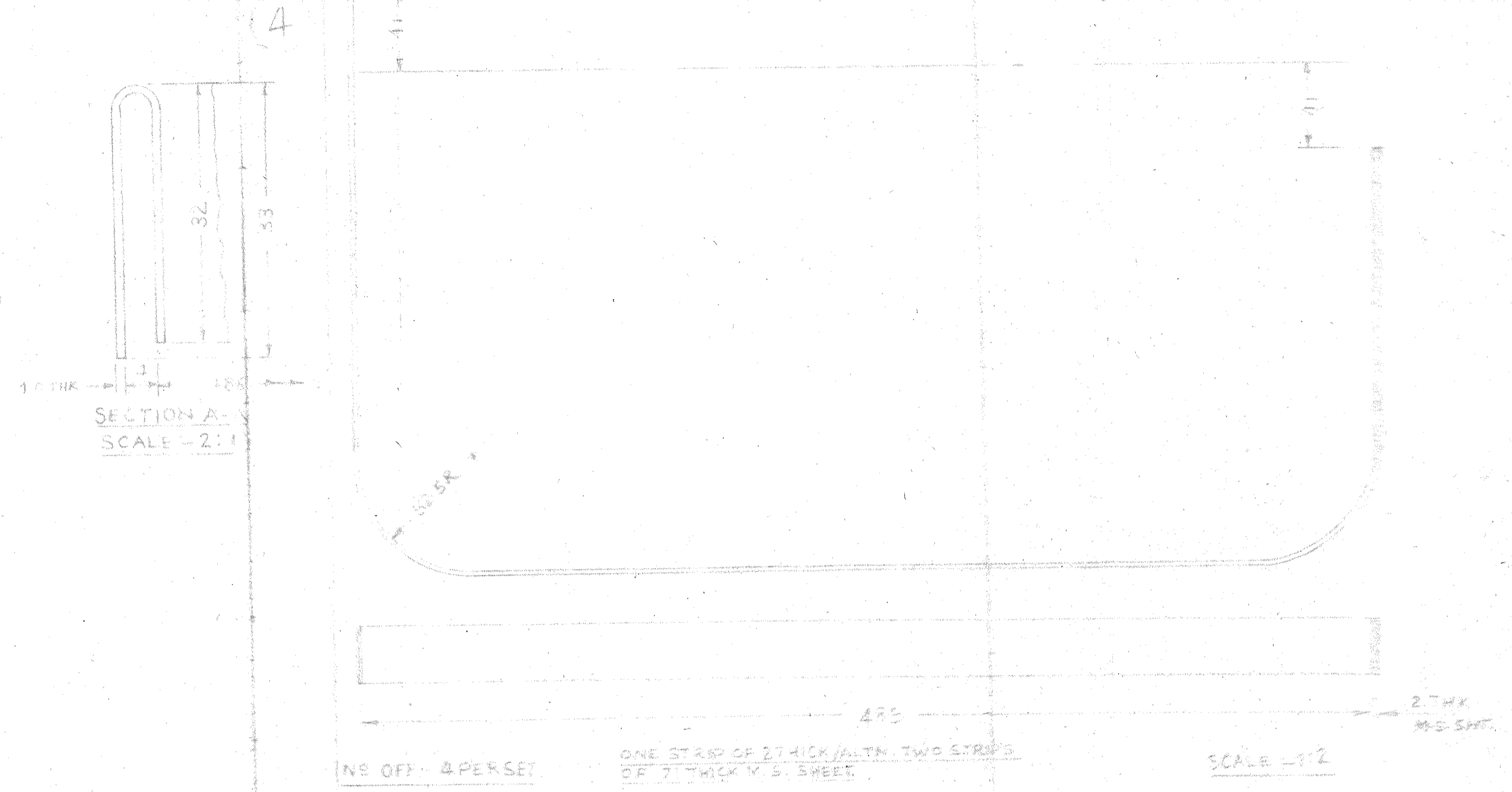
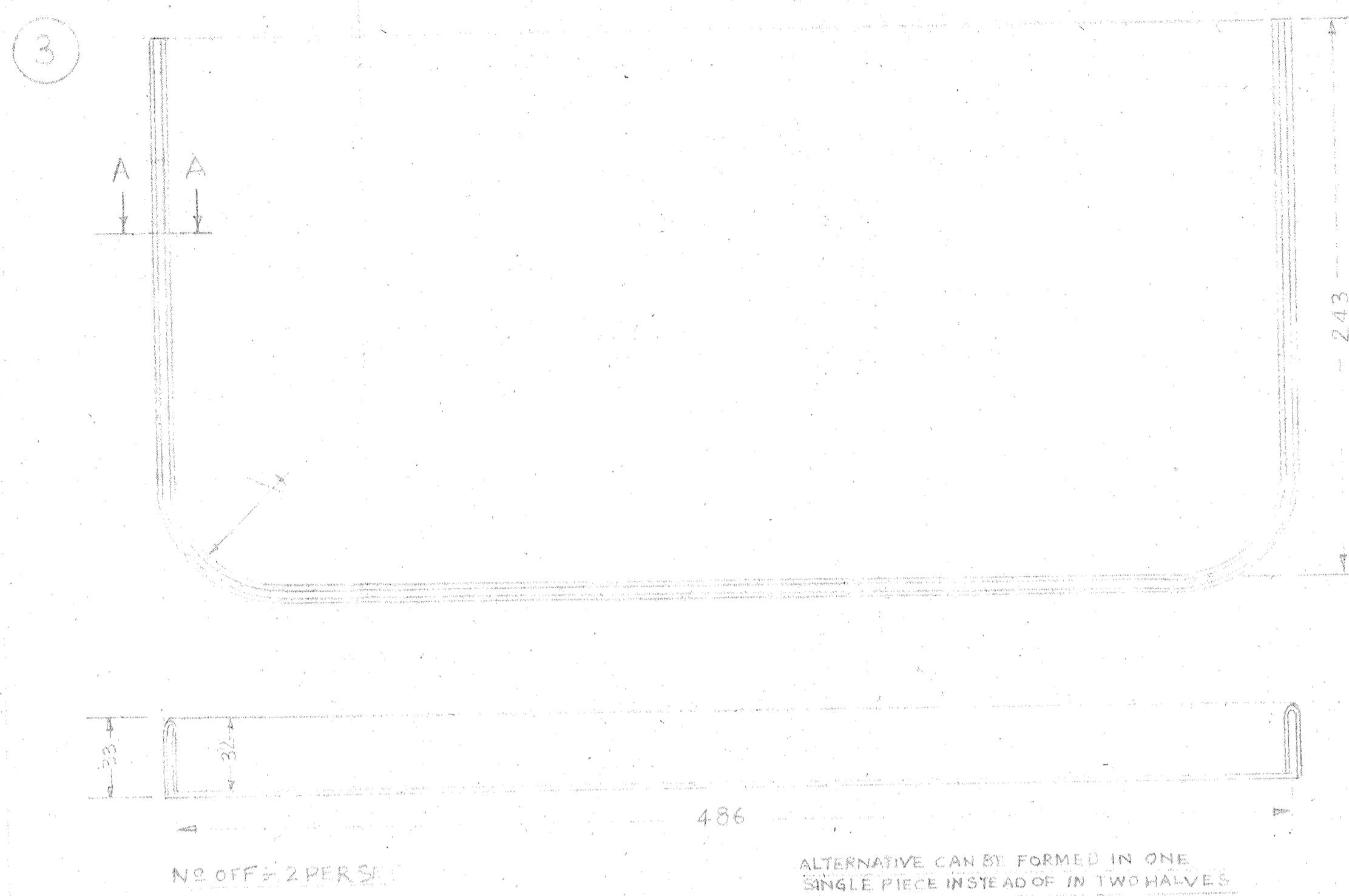
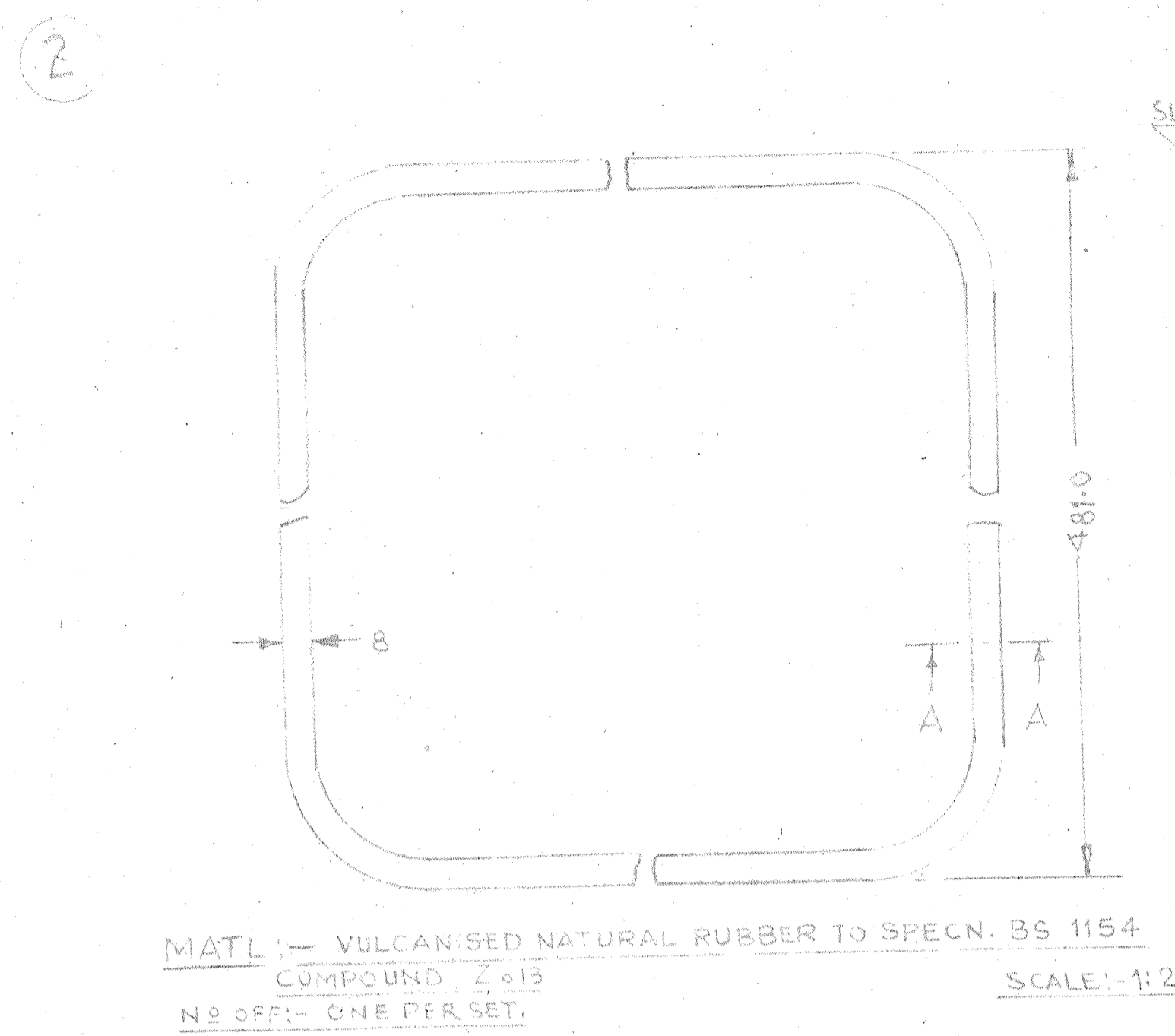



1	2	3	4
DRAWING CONVENTIONS CONFORM TO IS : 696 DIMNS ARE IN m.m. UNLESS OTHERWISE STATED			
PART NO.		DET No. 6	
ON SHTS.		SHTS.	
GEN.TOL. MEDIUM / <del>                    </del> CLASS TO IS: 2102			
DRG. No. <b>ARDE 2186</b>			

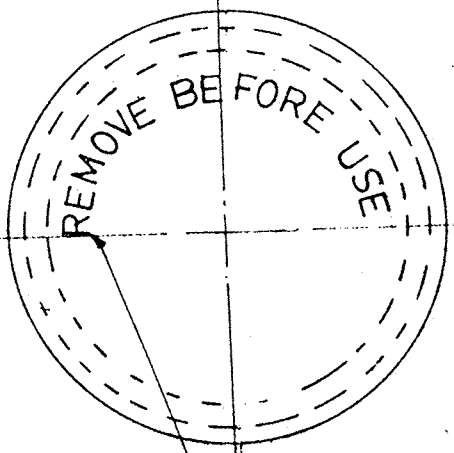
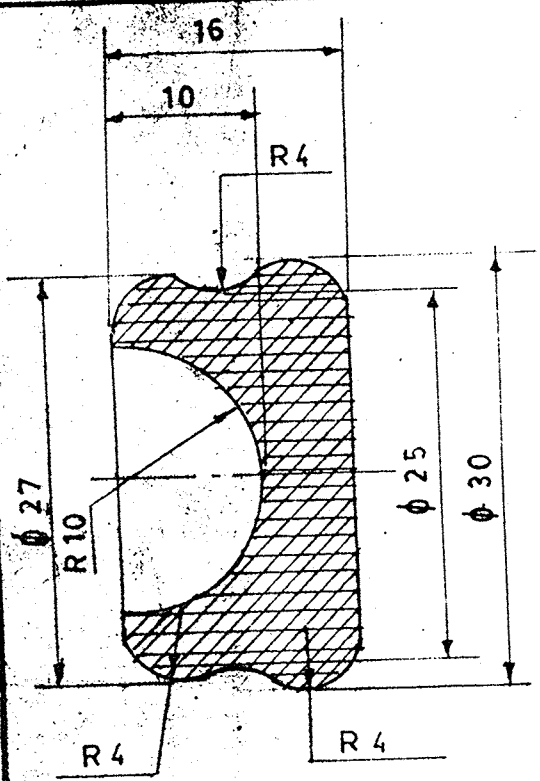

4 mm LETTERING  
TO BE STENCILLED WITH YELLOW INK

I	08-9-94		AMENDED VIDE AL No. 16194				
R. NO.	DATE :	AUTHORITY	BRIEF RECORD	ZONE	CD	GO	SIGN

DRG SEALED	DRN. SMP	CHD. <i>[Signature]</i>	TRD.	COMP.	ASSY DRG. ARDE 2186, SHT- 2
CD	PASSED	<i>[Signature]</i>	SCALE: 2:1	EST MASS:	DESIGN AUTHORITY
APPROVED	<i>[Signature]</i>		Gauge Schd:	DATE:	ARDE PUNE - 411 021
MATERIAL: NEOPRENE RUBBER TO SPEC. IND/ME/884 (PROV) CLASS C-2					
PROTECTIVE FINISH:					

TITLE:  
**RUBBER BUSH**

DRG. No. <b>ARDE 2186</b>		
DET. No. 6	SHTS.	SHT.No.
PART No.		
D. S. CAT. No.		
A.H.S.P.		

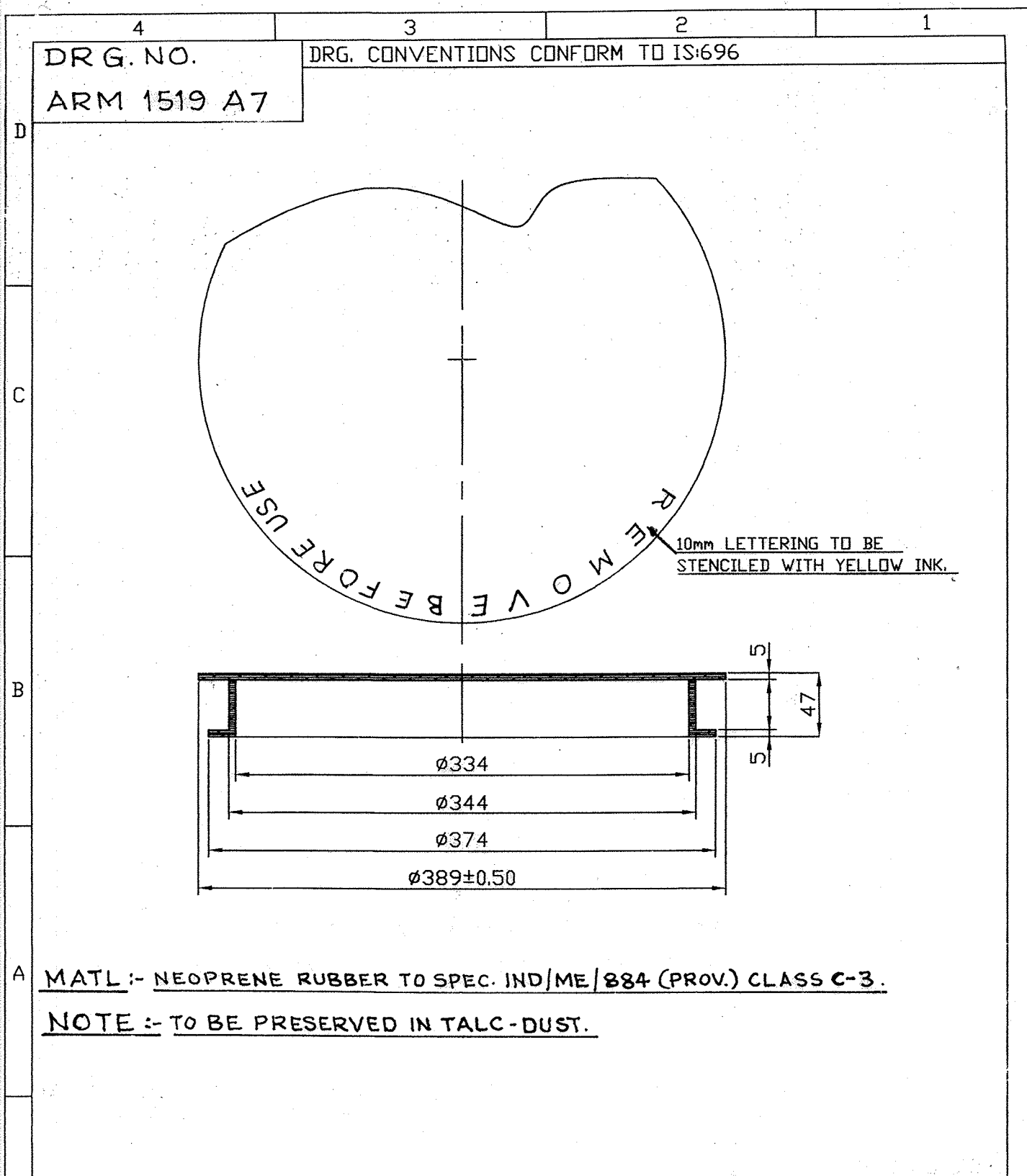

A MATL :- NEOPRENE RUBBER TO SPEC. IND/ME/884 (PROV.) CLASS C-3.  
NOTE :- TO BE PRESERVED IN TALC-DUST.

	03/08	PROVISIONAL			
R.NO.	DATE	AUTHORITY	BRIEF RECORD		ZONE
					CD GO SIGN.
DGN.		DATE	INITIAL	DIMENS. ARE IN mm	<b>D G A Q A</b> MINISTRY OF DEFENCE  APPD:- DRG. NO. <b>ARM 1519 A7</b> SHT. NO. 7 NO. OF SHTS 7
DRN.	03-09-08	(SST)		MATERIAL - AS ABOVE	
CHD.	03-09-08	HOB NIM		SEC. REF. NO.	
TCI REC				GAUGE SCHD. NO.	
				DRG. LIST NO. ARM 1519	
		SCALE:- 1:4	WIC AAIW	TITLE:- <u>RUBBER PLUG</u>	
		TOL:- UNTOL DIMEN. TO IS:2102			

DRAWING CONVENTIONS CONFORM TO IS : 696  
DIMNS ARE IN m.m. UNLESS OTHERWISE STATED

PART No. DET No. 4 SHTS 7 SHTS

GEN.TOL. MEDIUM / CLASS TO IS: 2102

**ARDE 2186**

DRG. No.

4 mm LETTERING TO BE  
STENCILLED WITH YELLOW  
INK.

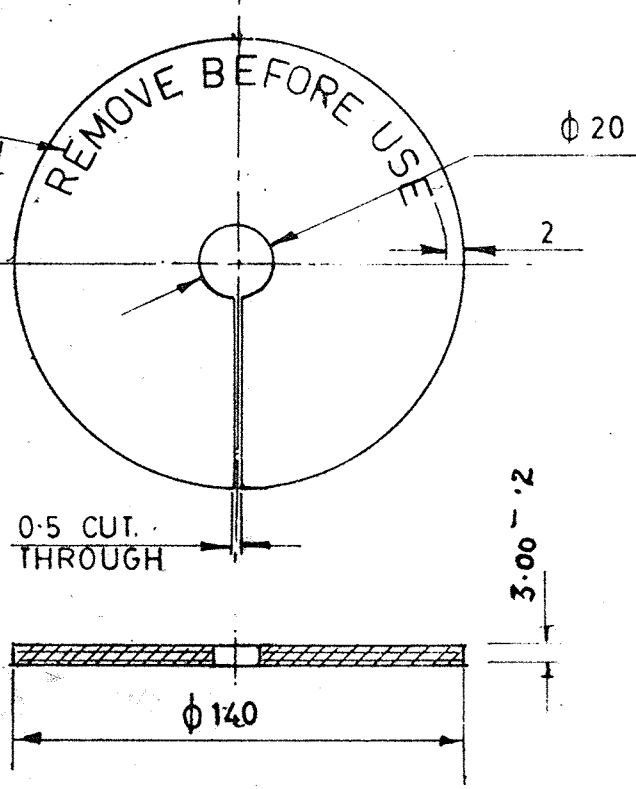

*M*  
Group Officer  
of Wash  
Department  
ARDE Pune  
Factory Dept.  
Pune 411 021  
Tel: 25-126 022  
Fax: 25-126 023

MATL: —

NEOPRENE RUBBER TO SPEC IND/ME/884 (PROV) CLASS C-2

NOTE: —

TO BE PRESERVED IN TALC-DUST.

1	10-3-98		AMENDED VIDE A-1 NO. 6/98	B-3	CD	GO
R. NO.	DATE	AUTHORITY	BRIEF RECORD	ZONE	SIGN	

DRG SEALED

DRN. S MP	CHD. <i>Billu</i>	TRD.	COMP.
CD	PASSED	SCALE: 1:2	EST MASS:
APPROVED <i>J. J. J.</i>	FOR DIRECTOR	GAUGE SCHD:	DATE: 16.6.93

ASSY DRG. ARDE 2186, SHT-2  
DESIGN AUTHORITY  
**ARDE PUNE - 411 021**

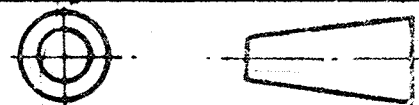

MATL: AS ABOVE

PROTECTIVE FINISH:-

TITLE:

WASHER

DRG. No.	<b>ARDE 2186</b>	
DET. No. 4	SHTS.	SHT.No.
PART No.		
D. S. CAT. No.		
A.H.S.P.		