

1 2 3 4 5 6 7 8 9 10 11 12 13 14 15 16

6089-SK-ON-DRG

GEN. TOL. FINE MEDIUM COARSE
 DRG. CONVENTION CONFORM TO INDIAN S.I.D.
 DIMS. IN mm UNLESS OTHERWISE STATED.

(PROVISIONAL)

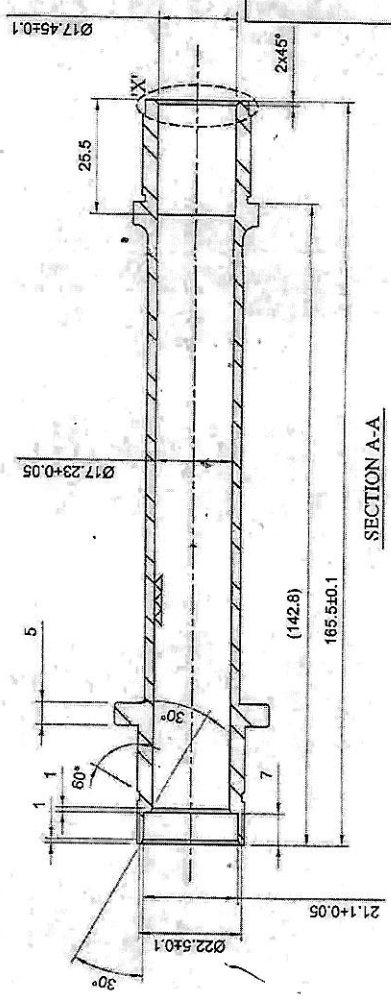
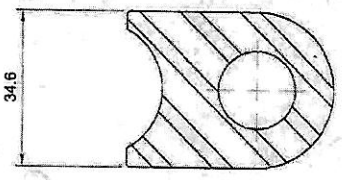
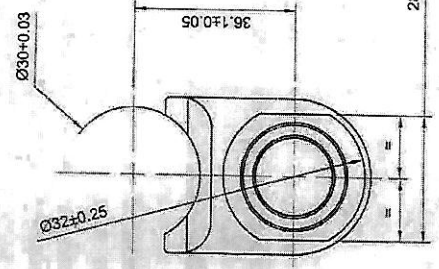
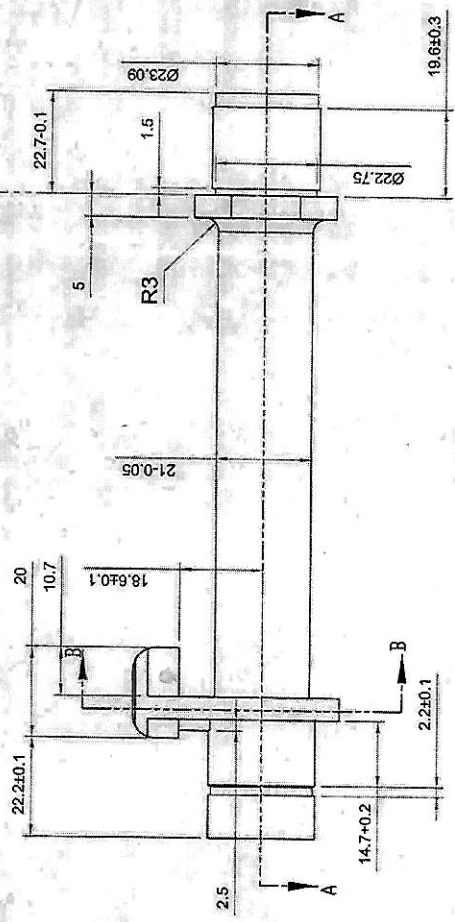
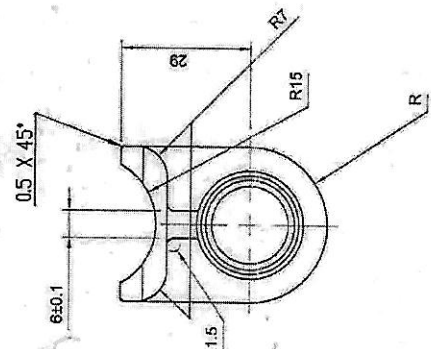
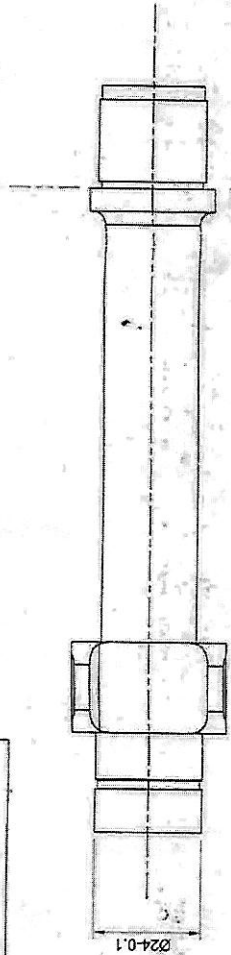
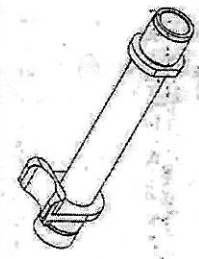

MATERIAL :- BS 970 PT.1 : 1993 Gr. 080 A 62 OR 080 A 62 OR 080 A 67 OR 817 M40 'T' CONDITION

HEAT TREATMENT :-

NORMALIZED LOCAL INDUCTION HEATING AT 'X' OR QUENCHED AND TEMPERED AT 250-300°C

PROTECTIVE FINISH :- PHOSPHATE TO SPECN. JSS. 0465.01-1994 CLASS-II (ACCELERATED), OIL FINISH.

18-02-2020
 J.T. WORKS

SCALE 1:1	DRG. NO. SK-5809	W.M/DDO
DATE 19-07-2018	APPROVED	WM/DDO
DRAWN TRACED/CHKD.		

LMG 7.62X51mm BELT FED CYLINDER GAS

SMALL ARMS FACTORY KANDIIR

ALL DIMENSIONS ARE IN mm.

IMPORTANT DIMS ARE MARKED THUS ⊕ (± 0.003)

INFORMATION MARKED THUS † TO BE MARKED ON SURFACE MARKED 'G' TO BE GROUND